

## The Building Regulations 2010

# Amendments to the Approved Documents

This document contains amendments to the following Approved Document:

**Approved Document B: Fire safety**

**Volume 1 – Dwellings**

**Volume 2 – Buildings other than dwellings**

**2019 edition incorporating the 2020 amendments**

June 2022

## Introduction

This document sets out amendments to guidance previously published in Approved Document B: Fire safety, Volume 1 – Dwellings and Volume 2 – Buildings other than dwellings, 2019 edition incorporating the 2020 amendments. These amendments will be incorporated in the online available Approved Document B Volume 1 and Volume 2 as from 1 December 2022. Hard copy versions from before that date will need to be read alongside the amendments listed in this document. You should always check the online version to know that you are looking at the most up to date version.

The changes highlighted in this amendment booklet take effect on 1 December 2022 for use in England. The 2019 edition incorporating the 2020 amendments will continue to apply where a building notice or an initial notice has been given to, or full plans deposited with, a local authority before 1 December 2022 and either the building work to which it relates:

- a. has started before that day; or
- b. is started within the period of six months beginning on that day.

Please note that ‘building notice’, ‘initial notice’ and ‘full plans’ have the meanings given in the Building Regulations 2010.

The changes focus on the following fire safety provisions:

- a. Ban of combustibile materials in and on the external walls of buildings:

Consequential amendments following the laying of the Building (Amendment) (England) Regulations 2022.

Updated provisions in Section 10 and 12 of Volume 1 and 2 respectively for residential buildings (purpose groups 1 and 2) with a storey 11m or more in height.

- a. Secure information boxes:  
A new recommendation for secure information boxes in blocks of flats with storeys over 11m.
- b. Evacuation alert systems:  
A new recommendation for evacuation alert systems in blocks of flats with storeys over 18m.
- c. Clarifications and corrections:  
Clarification of further diagrams, further text clarifications and corrections.

Full details of the changes are provided below.

## The Building Regulations 2010

**Approved Document B: Fire safety  
Volume 1 – Dwellings**

2019 edition incorporating the 2020 amendments

**List of amendments**

June 2022

**The Building Regulations****Notification of work****Page iv** **Replace** sub-paragraph (b) with the following.

- b. It is work exempted from the need to notify by regulation 12(6)(a) of, or Schedule 4 to, the Building Regulations.

**Section 0: Approved Document B: Fire safety –  
dwellings****Page 5** In Table 0.1 **Classification of purpose groups, replace** the 'Residential (institutional) 2(a)' row with the following.

Residential (institutional)	2(a)	<p>Hospital, home, school or other similar establishment, where people sleep on the premises. The building may be either of the following:</p> <ul style="list-style-type: none"> <li>• Living accommodation for, or accommodation for the treatment, care or maintenance of, either: <ul style="list-style-type: none"> <li>– disabled people with a range of impairments including physical, sensory and cognitive impairments, or mental health conditions</li> <li>– people under the age of 5 years.</li> </ul> </li> <li>• A place of lawful detention.</li> </ul>
--------------------------------	------	--

## Section 1: Fire detection and alarm systems

**Page 9** **Replace** paragraph 1.8 with the following.

- 1.8** A fire detection and alarm system should be installed where either of the following applies.
- A new **habitable room** is provided above or below the ground storey.
  - A new **habitable room** is provided at the ground storey, without a **final exit**.

**Replace** paragraph 1.9 with the following.

- 1.9** Smoke alarms should be provided in the **circulation spaces** of the **dwelling** in accordance with paragraphs 1.1 to 1.4.

## Section 2: Means of escape – dwellinghouses

**Page 17** **Replace** Diagram 2.7 with the following.

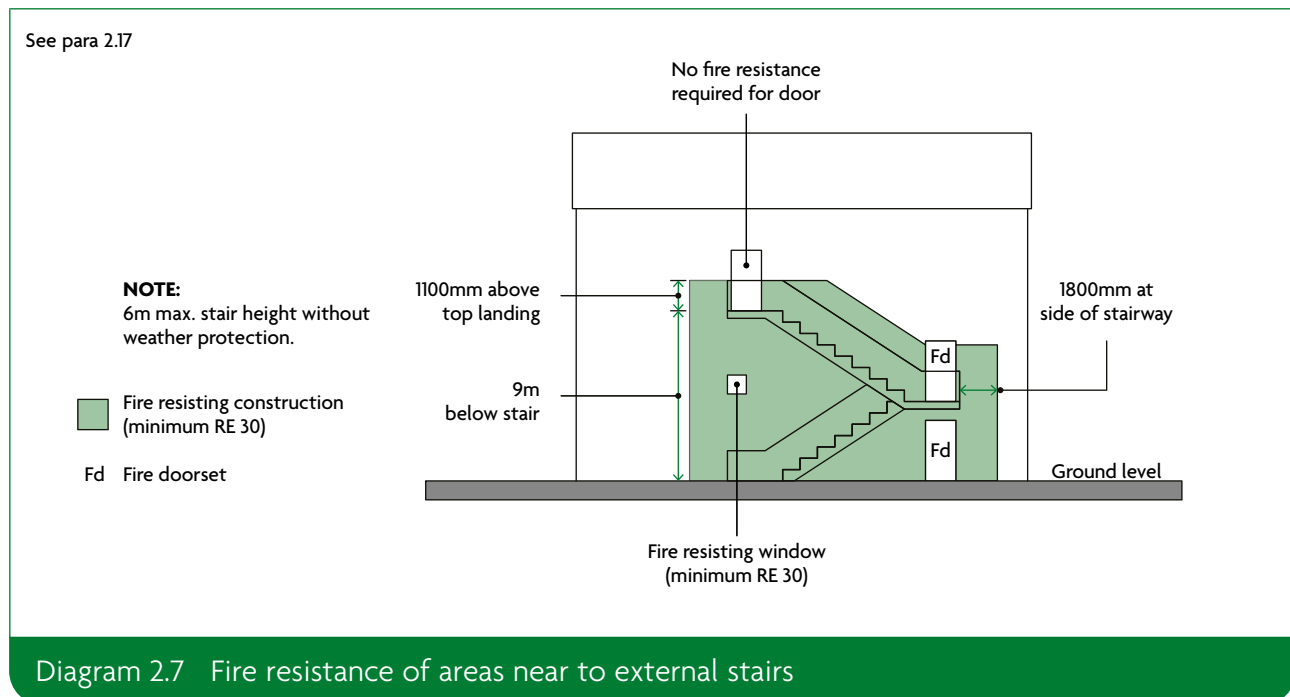

## Section 3: Means of escape – flats

**Page 21** **Replace** paragraph 3.14 with the following.

**3.14** The internal arrangement of single storey or multi-storey flats should comply with paragraphs 3.15 to 3.17. Alternatively, the guidance in paragraphs 3.18 to 3.22 may be followed.

Where a flat is accessed via the common parts of a block of flats it may be necessary to provide a protected entrance hall to meet the provisions of paragraph 3.28 and Diagram 3.9.

**Page 22** Paragraph 3.18, **replace** sub-paragraph (c) with the following.

c. Provide an alternative exit from the flat complying with paragraph 3.19.

**Replace** Diagram 3.2 with the following.

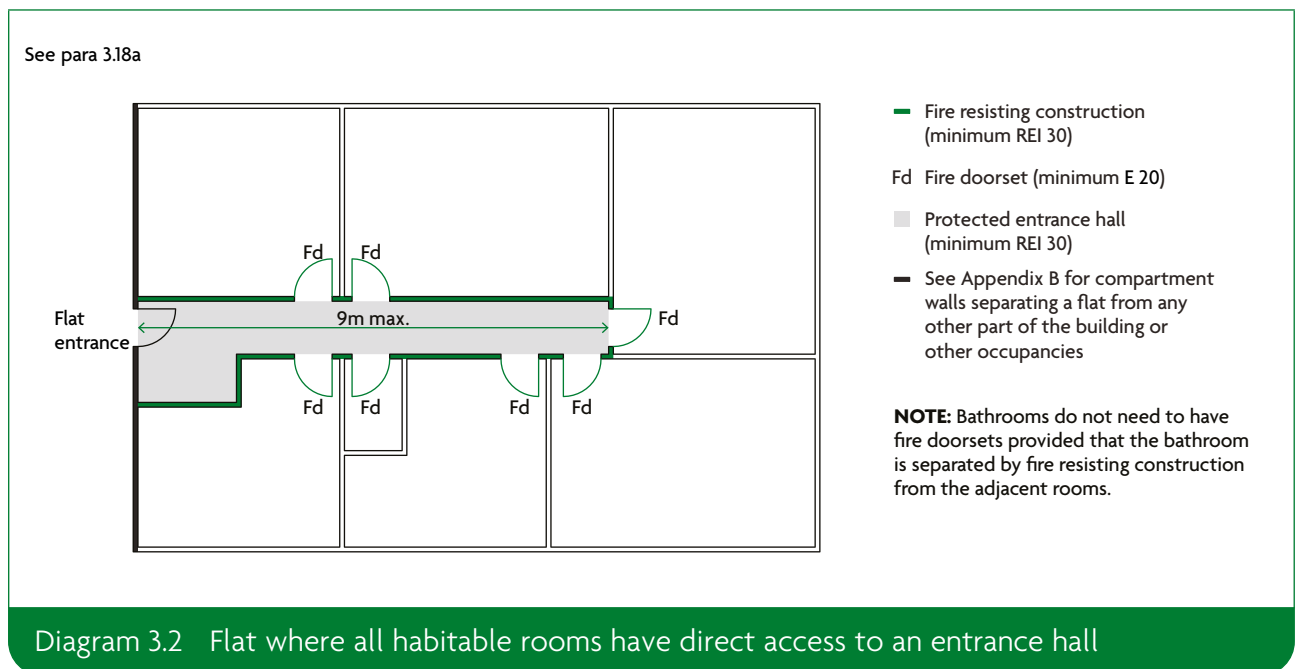

**Replace** Diagram 3.3 with the following.

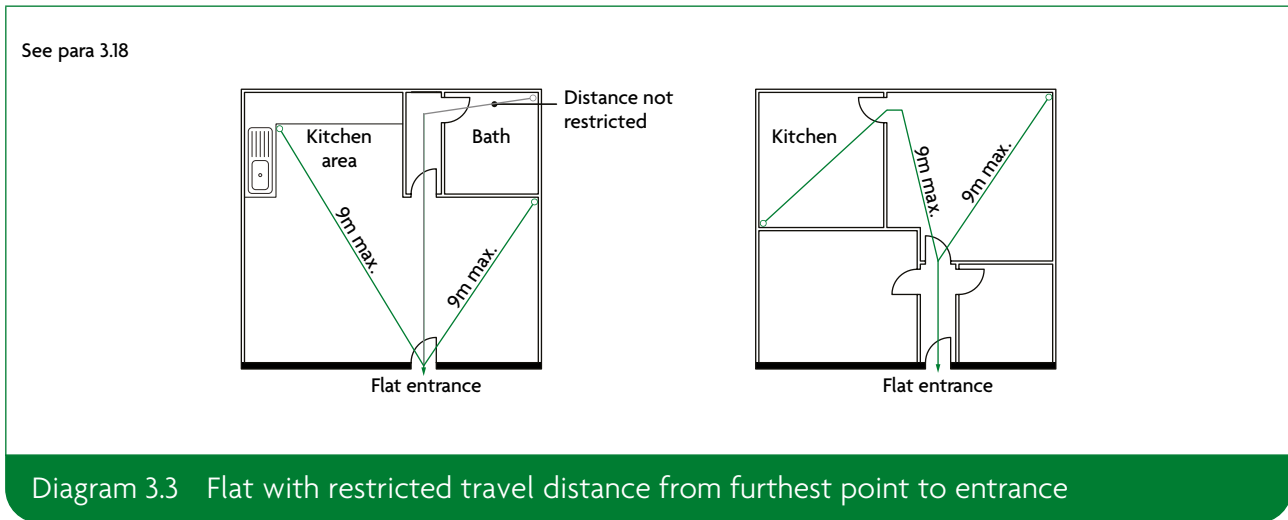

**Page 23** **Replace** Diagram 3.4 with the following.

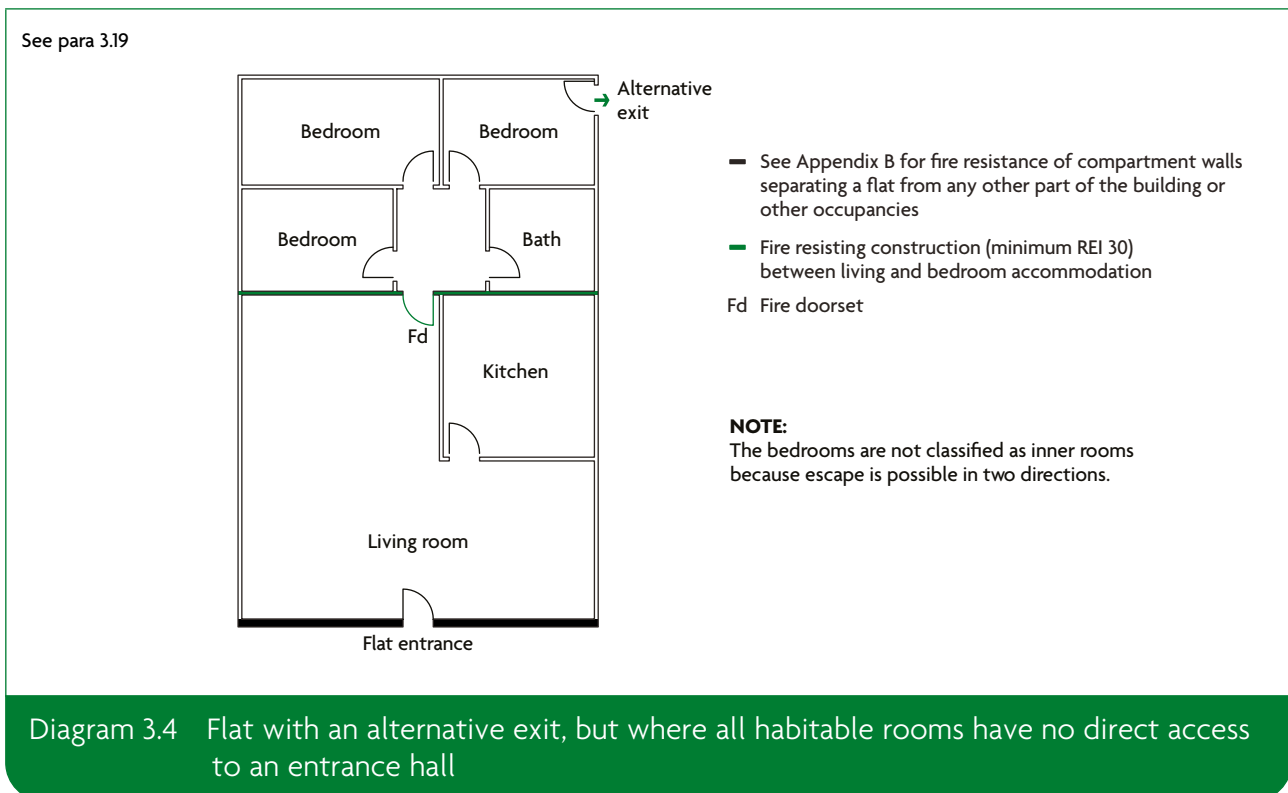

Paragraph 3.21, **replace** sub-paragraph (c) with the following.

- c. **Approach 3** – provide a **protected stairway** plus a sprinkler system in accordance with Appendix E (smoke alarms should also be provided in accordance with Section 1).

**Page 24** Replace Diagram 3.5 with the following.

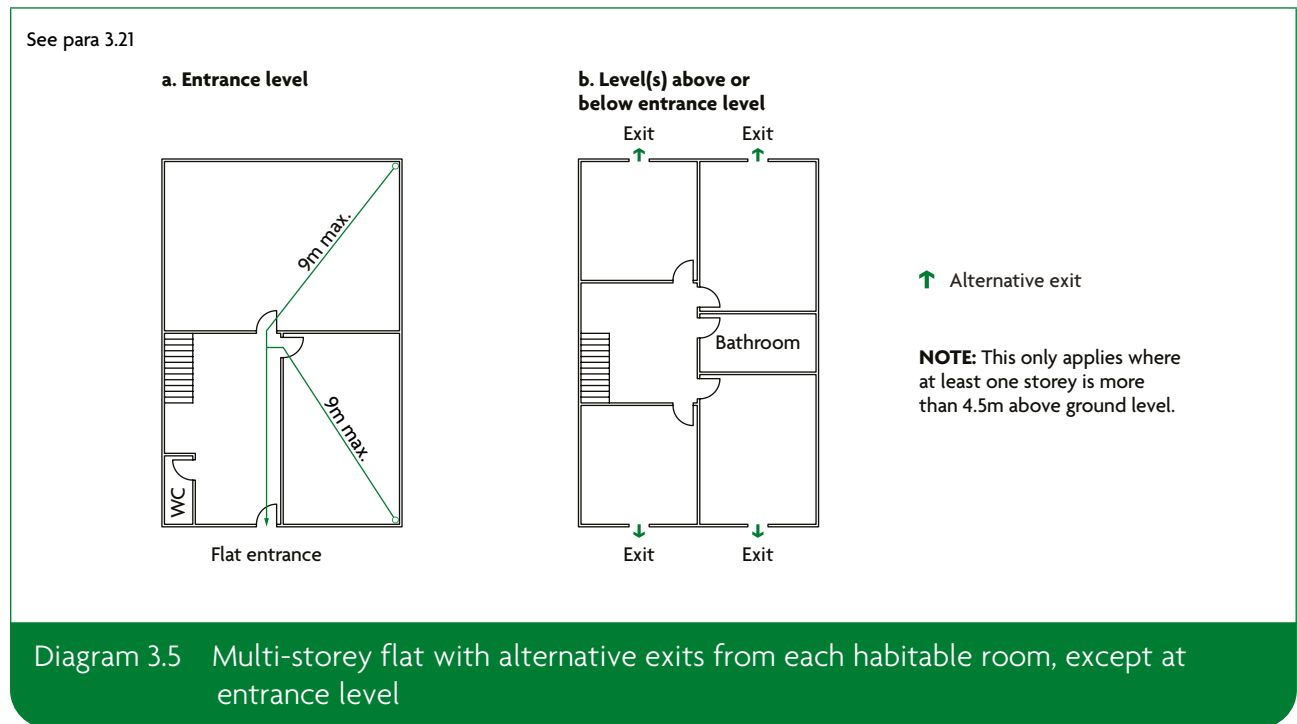

**Replace** Diagram 3.6 with the following.

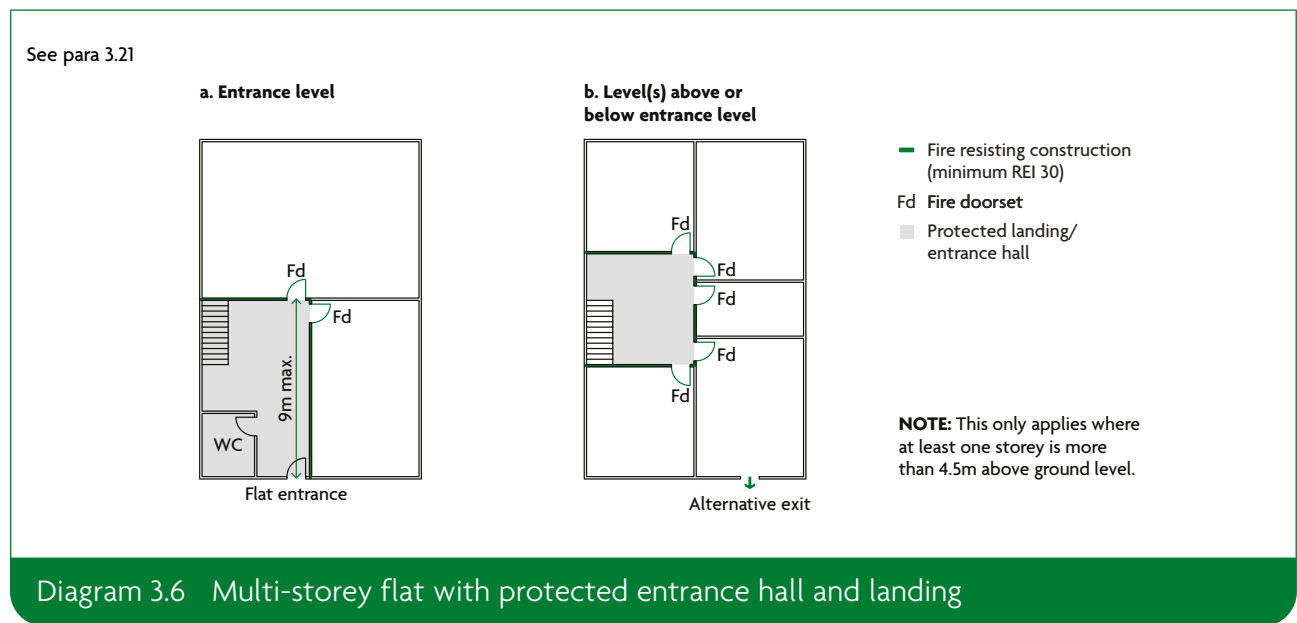

**Page 26** **Replace** paragraph 3.25 with the following.

**3.25** The following paragraphs deal with **means of escape** from the entrance doors of flats to a **final exit**. They do not apply to flats with a top storey that is a maximum of 4.5m above ground level (designed in accordance with paragraphs 3.15 to 3.17).

Reference should also be made to the following.

- a. Requirement B3 regarding **compartment walls** and **protected shafts**.
- b. Requirement B5 regarding access for the fire and rescue service.

**Page 27** **Replace** Diagram 3.7 with the following.

See para 3.27 and 3.36

**a. Corridor access flats**

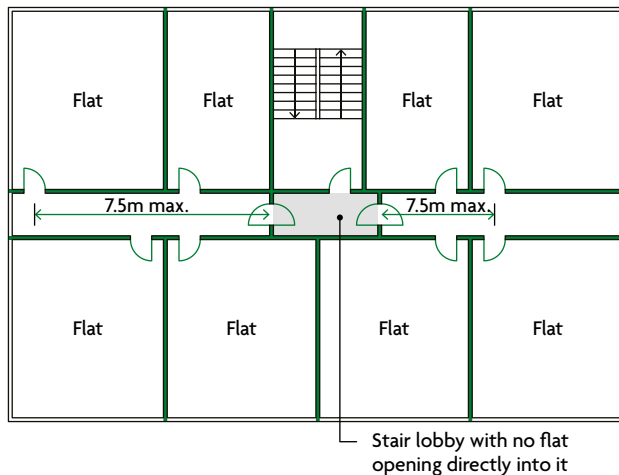

**b. Lobby access flats**

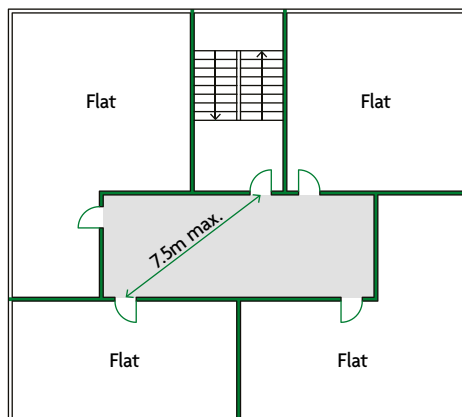

■ Shaded areas indicate zones where ventilation should be provided in accordance with paragraphs 3.50 to 3.53 (An external wall vent or smoke shaft located anywhere in the shaded area)

— Fire resisting construction

**NOTES:**

1. The arrangements shown also apply to the top storey.
2. See Diagram 3.9 for small single stair buildings.
3. All doors shown are fire doorsets.
4. Where travel distance is measured to a stair lobby, the lobby must not provide direct access to any storage room, flat or other space containing a potential fire hazard.
5. For further guidance on the performance of the fire doorsets from the corridor to the flat and/or stairway refer to Appendix C, Table C1.

Diagram 3.7 Flats served by one common stair



**Page 28** Replace Diagram 3.8 with the following.

See para 3.27 and 3.36

**a. Corridor access without dead ends**

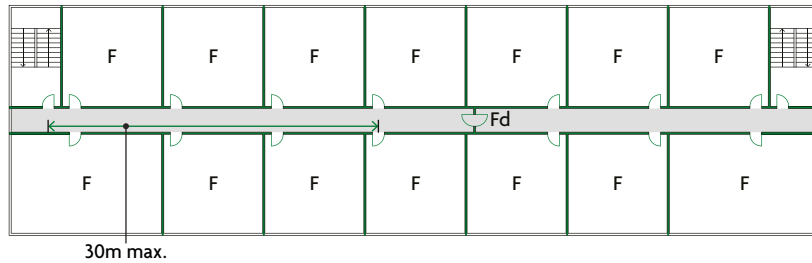

**b. Corridor access with dead ends**

The central door may be omitted if maximum travel distance is not more than 15m

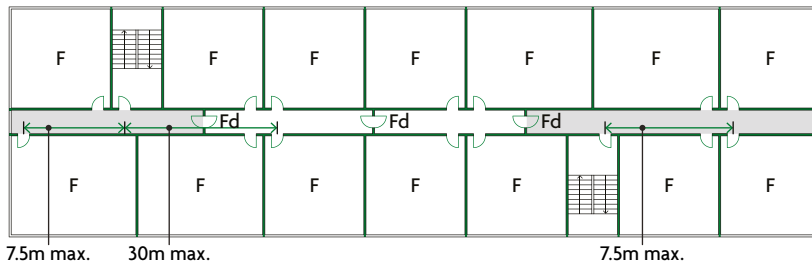

**c. 'T' junction with main corridor**

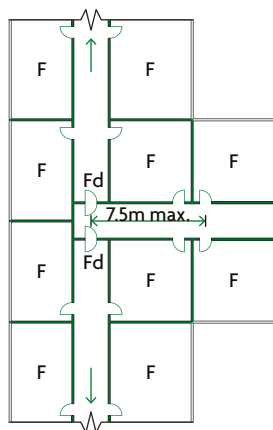

- Fd Cross-corridor fire doorset
- F Flat
- Shaded areas indicate zones where ventilation should be provided in accordance with paragraphs 3.50 to 3.53 (An external wall vent or smoke shaft located anywhere in the shaded area)
- Fire resisting construction
- Escape route

**NOTES:**

1. The arrangements shown also apply to the top storey.
2. For further guidance on the fire resistance rating of the fire doorsets from the corridor to the flat and/or stairway refer to Appendix C, Table C1.

Diagram 3.8 Flats served by more than one common stair

**Page 29** Replace Diagram 3.9 with the following.

See para 3.28

**a. Small single stair building**

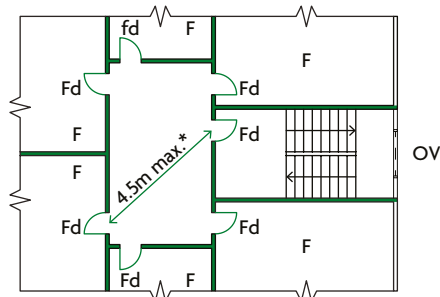

- Fire resisting construction
- OV Openable vent at high level for fire service use (1.0m<sup>2</sup> minimum free area); see paragraph 3.28e
- F Flat
- Fd Fire doorset

\*If smoke control is provided in the lobby, the travel distance can be increased to 7.5m maximum (see Diagram 3.7, example b).

**b. Small single stair building with no more than two flats per storey**

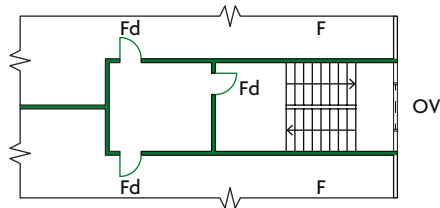

**NOTES:**

1. The arrangements shown also apply to the top storey.
2. If the travel distance across the lobby in diagram (a) exceeds 4.5m, Diagram 3.7 applies.
3. Where, in Diagram (b), the lobby between the common stair and the flat is omitted in small single stair buildings, an automatic opening vent with a geometric free area of at least 1m<sup>2</sup> is required at the top of the stair, which is operated on detection of smoke at any storey in the stair.
4. For further guidance on the fire rating of the fire doorsets from the corridor to the flat and/or stairway refer to Appendix C, Table C1.

The door between stair and lobby should be free from security fastenings.

If the flats have protected entrance halls, the lobby between the common stair and flat entrance is not essential.

Diagram 3.9 Common escape route in small single stair building

**Page 30** Replace paragraph 3.41 with the following.

**3.41** Except for two storey blocks of flats, all escape routes should have adequate artificial lighting. If the mains electricity power supply fails, escape lighting should illuminate the route (including external escape routes).

**Page 32** Paragraph 3.51, replace sub-paragraph (b)(iii) with the following.

- iii. The smoke shaft should be constructed from a class A1 material. All vents should either be a smoke leakage ( $S_a$ ) rated fire doorset (see Appendix C, Table C1, item 2.e for minimum fire resistance) or fitted with a smoke control damper achieving the same period of fire resistance and designed to operate as described below. The shaft should be vertical from base to head, with a maximum of 4m at a maximum inclined angle of 30 degrees.

**Page 33** Replace paragraph 3.62 with the following.

**3.62** Every common stair should be a protected stairway. Where the protected stairway passes from one compartment to another, it should be within a protected shaft.

**Page 34** Paragraph 3.66, replace sub-paragraph (b) with the following.

b. The stair meets the provisions in paragraph 3.68.

**Page 35** Replace Diagram 3.11 with the following.

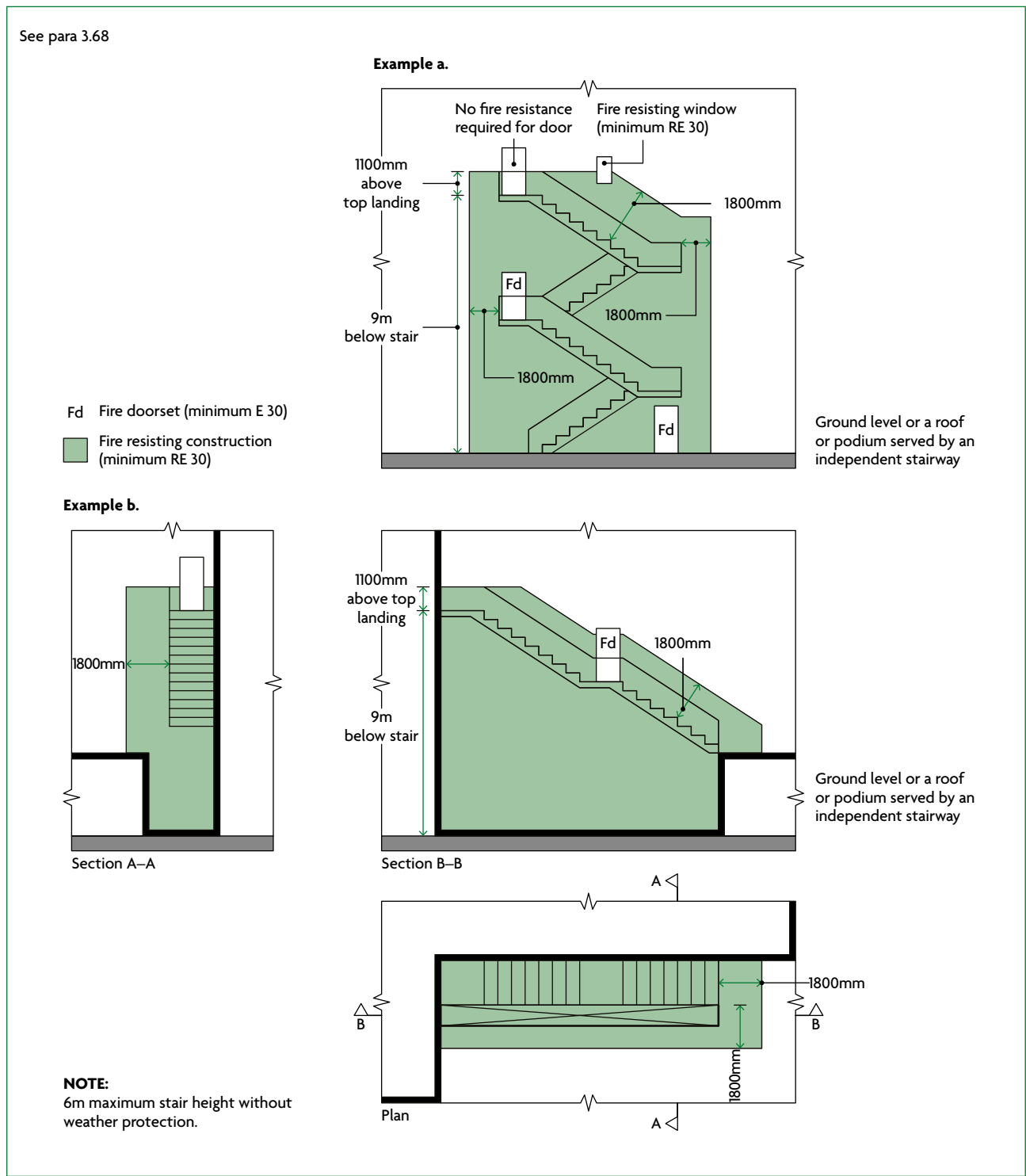
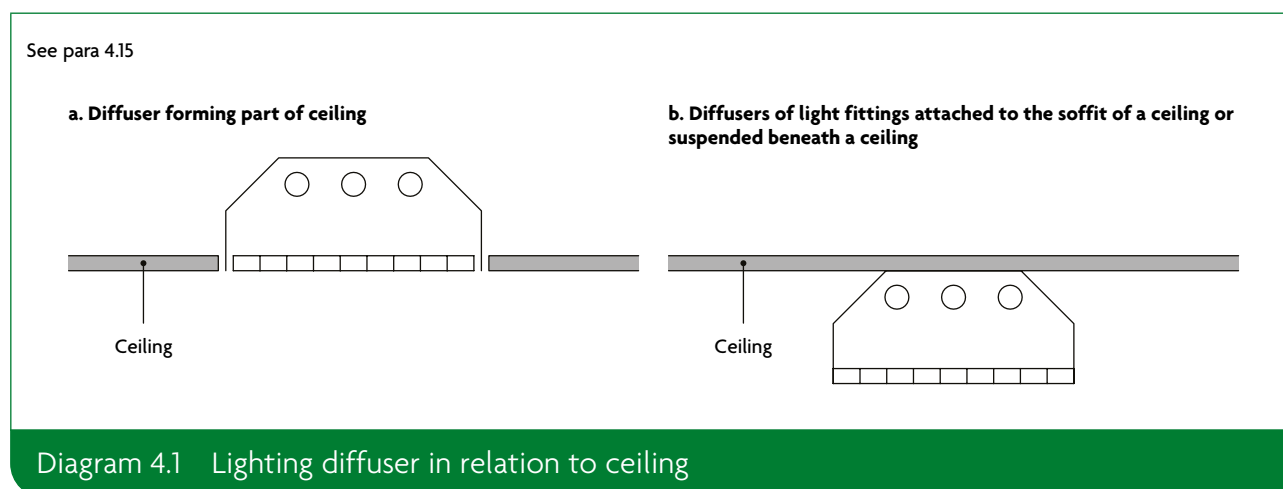

Diagram 3.11 Fire resistance of areas near to external stairs

## Section 4: Wall and ceiling linings

**Page 45** **Replace** Diagram 4.1 with the following.



## Section 5: Internal fire spread – dwellinghouses

**Page 50** **Replace** paragraph 5.1 with the following.

- 5.1** Elements of structure such as structural frames, beams, columns, loadbearing walls (internal and external), floor structures and gallery structures should have, as a minimum, the fire resistance given in Appendix B, Table B3.

## Section 6: Loadbearing elements of structures – flats

**Page 57** **Replace** the section title with the following.

## Section 6: Loadbearing elements of structure – flats

**Replace** paragraph 6.1 with the following.

- 6.1** Elements of structure such as structural frames, beams, columns, loadbearing walls (internal and external), floor structures and gallery structures should have, as a minimum, the fire resistance given in Appendix B, Table B3.

**NOTE:** If one element of structure supports or stabilises another, as a minimum the supporting element should have the same fire resistance as the other element.

## Section 7: Compartmentation/sprinklers – flats

**Page 59** Replace paragraph 7.1 with the following.

- 7.1** All of the following should be provided as compartment walls and compartment floors and should have, as a minimum, the fire resistance given in Appendix B, Table B3.
- Any floor (unless it is within a flat, i.e. between one storey and another within one individual dwelling).
  - Any wall separating a flat from another part of the building.
  - Any wall enclosing a refuse storage chamber.
  - Any wall common to two or more buildings.

**Page 62** Replace Diagram 7.1 with the following.

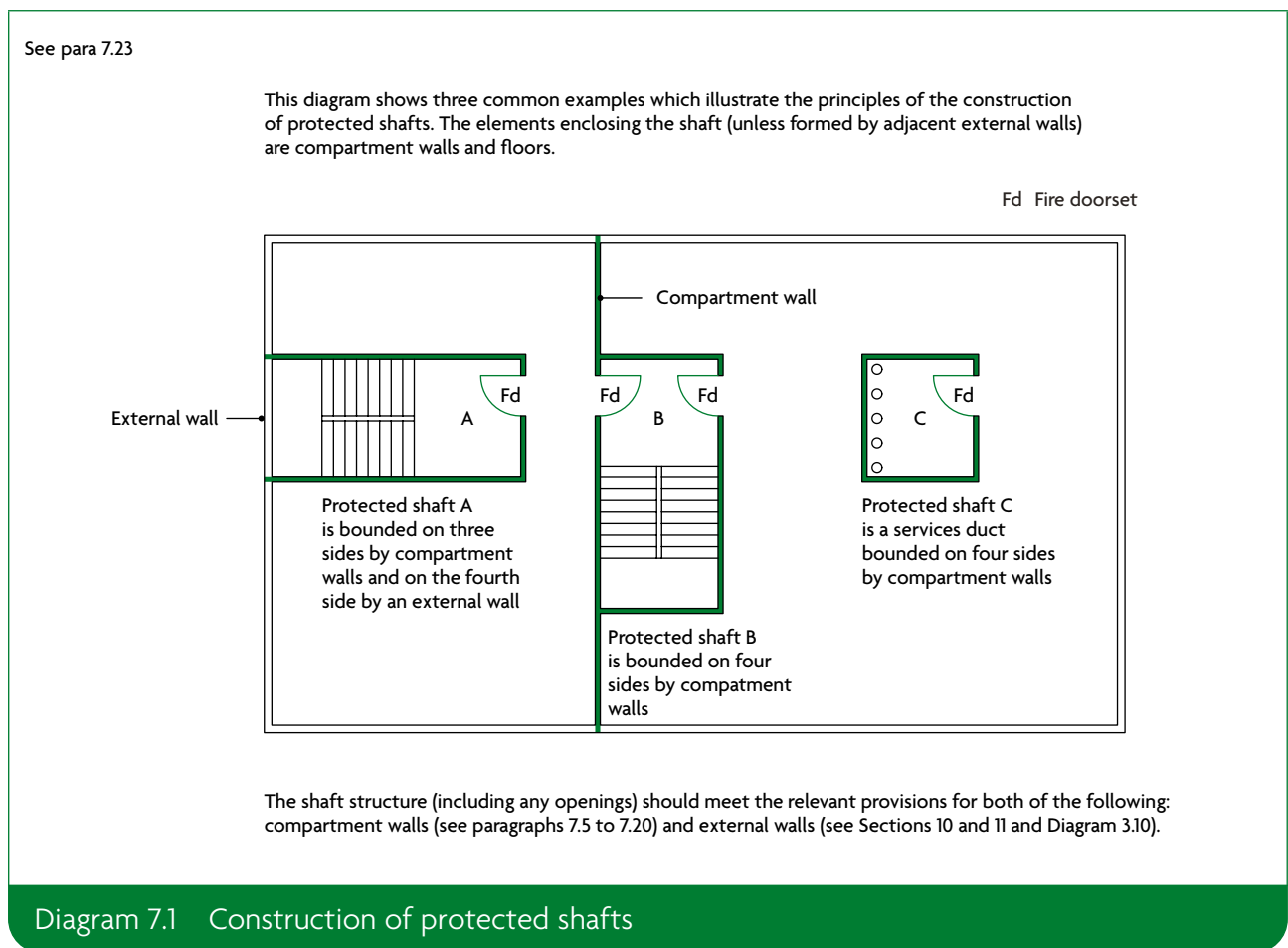

**Page 63** Replace Diagram 7.2 with the following.

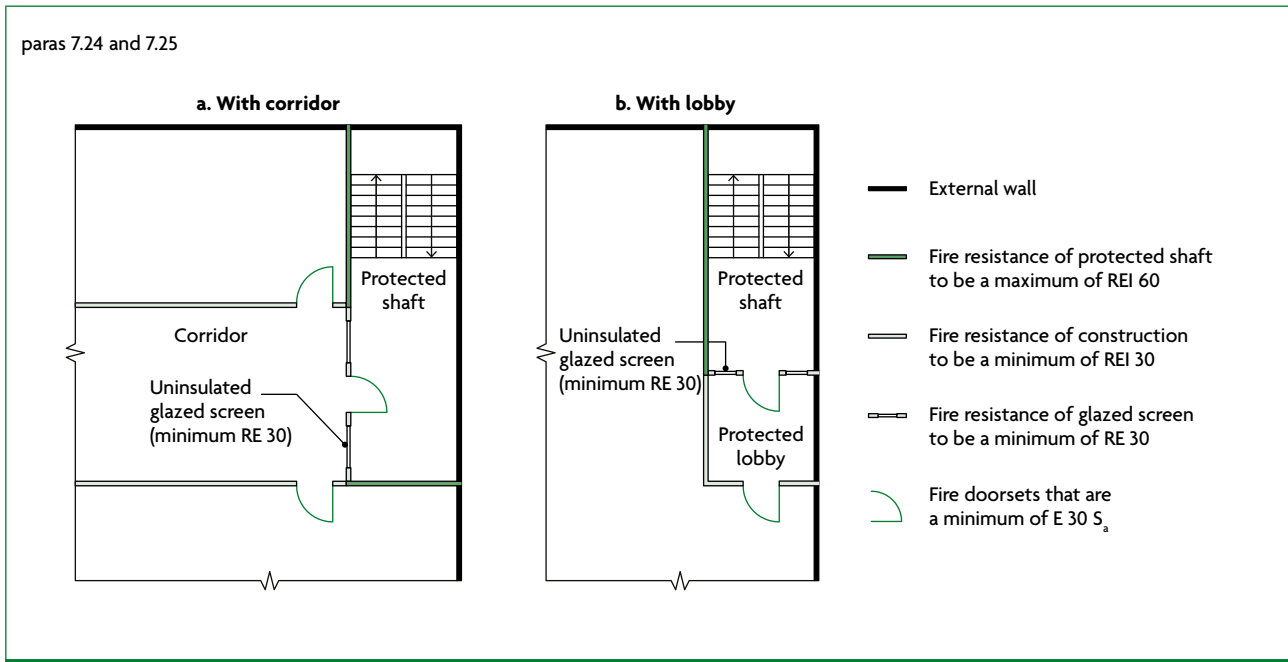

Diagram 7.2 Uninsulated glazed screen separating protected shaft from lobby or corridor

## Section 8: Cavities – flats

**Page 65** Replace subheading before paragraph 8.3 with the following.

### Junctions and edges of cavities

**Page 67** Replace Diagram 8.3 with the following.

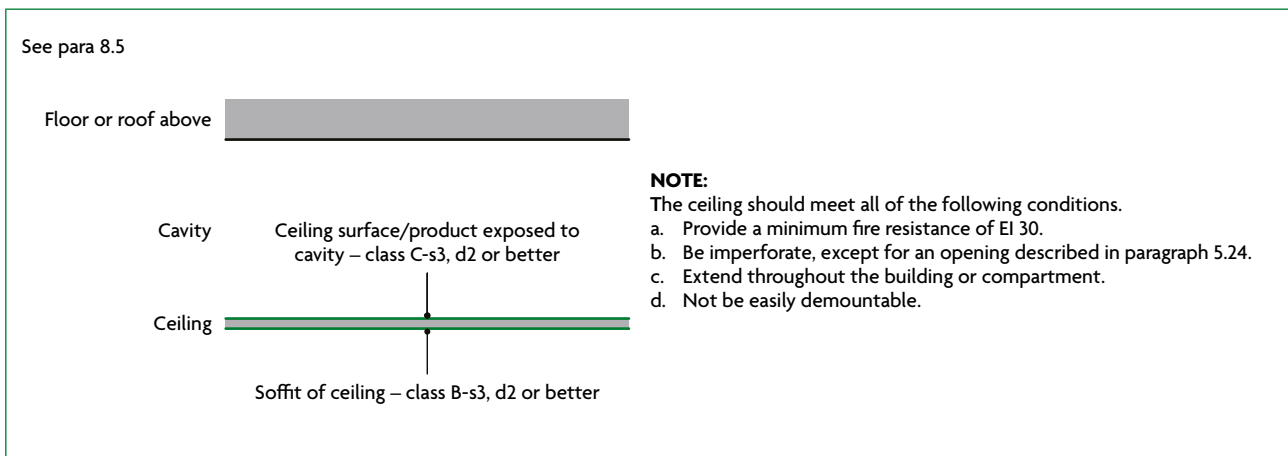

Diagram 8.3 Fire resisting ceiling below cavity

**Page 68** Replace paragraph 8.9 with the following.

**8.9** Cavity barriers should meet the requirements set out in paragraphs 5.21 to 5.24.

## Section 9: Protection of openings and fire-stopping

**Page 69** **Replace** paragraph 9.1 with the following.

- 9.1** Every joint, imperfect fit and opening for services through a **fire-separating element** should be sealed with **fire-stopping** to ensure that the **fire resistance** of the element is not impaired. **Fire-stopping** delays the spread of fire and, generally, the spread of smoke as well.

**Page 70** **Replace** Diagram 9.2 with the following.

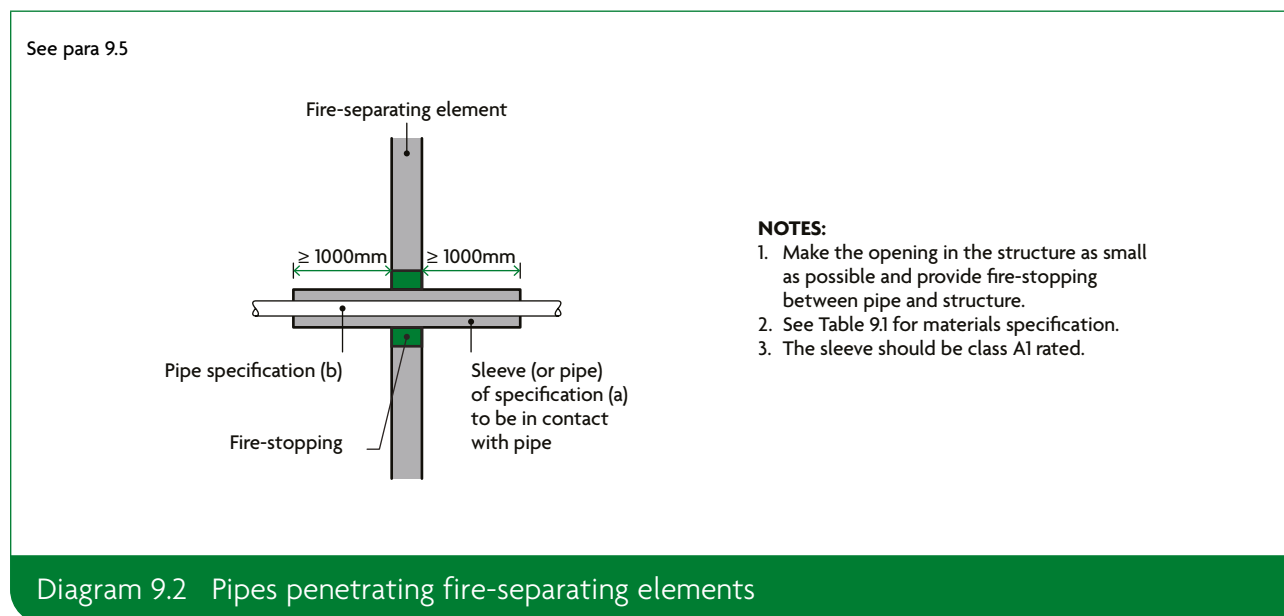

**Page 71** In Table 9.1 **Maximum nominal internal diameter of pipes passing through a compartment wall/floor**, **replace** the table title with the following.

**Table 9.1 Maximum nominal internal diameter of pipes passing through a fire-separating element**

**Page 72** **Replace** paragraph 9.12 with the following.

- 9.12** If air handling ducts pass through **fire-separating elements**, the fire performance of the elements should be maintained using one or more of the following four methods. In most ductwork systems, a combination of the four methods is best.
- a. Method 1 – thermally activated **fire dampers**.
  - b. Method 2 – **fire resisting** enclosures.
  - c. Method 3 – protection using **fire resisting** ductwork.
  - d. Method 4 – automatically activated **fire and smoke dampers** triggered by smoke detectors.

## Requirement B4: External fire spread

**Page 76** Replace the requirement text with the following.

### Requirement

*Requirement*

*Limits on application*

**External fire spread**

- B4.** (1) The external walls of the building shall adequately resist the spread of fire over the walls and from one building to another having regard to the height, use and position of the building.
- (2) The roof of the building shall adequately resist the spread of fire over the roof and from one building to another, having regard to the use and position of the building.

### Regulation

**Regulation 7 – Materials and workmanship**

- (1) Building work shall be carried out—
- (a) with adequate and proper materials which—
    - (i) are appropriate for the circumstances in which they are used,
    - (ii) are adequately mixed or prepared, and
    - (iii) are applied, used or fixed so as adequately to perform the functions for which they are designed; and
  - (b) in a workmanlike manner.
- (1A) Building work shall be carried out so that relevant metal composite material does not become part of an external wall, or specified attachment, of any building.
- (2) Subject to paragraph (3), building work shall be carried out so that materials which become part of an external wall, or specified attachment, of a relevant building are of European Classification A2-s1, d0 or A1 (classified in accordance with the reaction to fire classification).



**Regulation continued**

(3) Paragraph (2) does not apply to—

- (a) cavity trays when used between two leaves of masonry;
- (b) any part of a roof (other than any part of a roof which falls within paragraph (iv) of regulation 2(6)) if that part is connected to an external wall;
- (c) door frames and doors;
- (d) electrical installations;
- (da) fibre optic cables;
- (e) insulation and water proofing materials used below ground level or up to 300mm above that level;
- (f) intumescent and fire stopping materials where the inclusion of the materials is necessary to meet the requirements of Part B of Schedule 1;
- (g) membranes;
- (h) seals, gaskets, fixings, sealants and backer rods;
- (ha) components associated with a solar shading device, excluding components whose primary function is to provide shade or deflect sunlight, such as the awning, curtain or slats;
- (i) thermal break materials where the inclusion of the materials is necessary to meet the thermal bridging requirements of Part L of Schedule 1;
- (j) window frames and glass; or
- (k) materials which form the top horizontal floor layer of a balcony which are of European Classification A1fl or A2fl-sl (classified in accordance with the reaction to fire classification) provided that the entire layer has an impermeate substrate under it.

(4) In this regulation—

- (a) a “relevant building” means a building with a storey (not including roof-top plant areas or any storey consisting exclusively of plant rooms) at least 18 metres above ground level and which—
  - (i) contains one or more dwellings;
  - (ii) contains an institution; or
  - (iii) contains a room for residential purposes; and
- (b) “above ground level” in relation to a storey means above ground level when measured from the lowest ground level adjoining the outside of a building to the top of the floor surface of the storey.

## Section 10: Resisting fire spread over external walls

**Pages 79 to 82** Replace Section 10 with the following.

# Section 10: Resisting fire spread over external walls

## Introduction

**10.1** The **external wall** of a **building** should not provide a medium for fire spread if that is likely to be a risk to health and safety. Combustible materials and **cavities** in **external walls** and attachments to them can present such a risk, particularly in tall **buildings**. The guidance in this section is designed to reduce the risk of fire spread as well as the risk of ignition from flames coming from adjacent **buildings**.

## Fire resistance

**10.2** This section provides guidance on resisting fire spread over **external walls**; however, it does not deal with **fire resistance** of **external walls**. An **external wall** may need **fire resistance** to meet the provisions of Section 3 (Means of escape – flats), Section 6 (Loadbearing elements of structure – flats), Section 11 (Resisting fire spread from one building to another) or Section 15 (Access to buildings for firefighting personnel – flats).

## Combustibility of external walls

**10.3** The **external walls** of **buildings** other than those described in regulation 7(4) of the Building Regulations should achieve either of the following.

- a. Follow the provisions given in paragraphs 10.5 to 10.9, which provide guidance on all of the following.
  - i. External surfaces.
  - ii. Materials and products.
  - iii. **Cavities** and **cavity barriers**.
- b. Meet the performance criteria given in BRE report BR 135 for **external walls** using full-scale test data from **BS 8414-1** or **BS 8414-2**.

**10.4** In relation to **buildings** of any **height** or use, consideration should be given to the choice of materials (including their extent and arrangement) used for the **external wall**, or attachments to the wall (e.g. balconies, etc.), to reduce the risk of fire spread over the wall.

## External surfaces

**10.5** The external surfaces (i.e. outermost external material) of **external walls** should comply with the provisions in Table 10.1. The provisions in Table 10.1 apply to each wall individually in relation to its proximity to the **relevant boundary**.

**Table 10.1 Reaction to fire performance of external surface of walls**

Building type	Building height	Less than 1000mm from the relevant boundary	1000mm or more from the relevant boundary
'Relevant buildings' as defined in regulation 7(4) (see paragraph 10.14)		Class A2-s1, d0 <sup>(1)</sup> or better	Class A2-s1, d0 <sup>(1)</sup> or better
All 'residential' purpose groups (purpose groups 1 and 2)	More than 11m	Class A2-s1, d0 <sup>(2)</sup> or better	Class A2-s1, d0 <sup>(2)</sup> or better
	11m or less	Class B-s3, d2 <sup>(2)</sup> or better	No provisions
Assembly and recreation	More than 18m	Class B-s3, d2 <sup>(2)</sup> or better	From ground level to 18m: class C-s3, d2 <sup>(3)</sup> or better From 18m in height and above: class B-s3, d2 <sup>(2)</sup> or better
	18m or less	Class B-s3, d2 <sup>(2)</sup> or better	Up to 10m above ground level: class C-s3, d2 <sup>(3)</sup> or better Up to 10m above a roof or any part of the building to which the public have access: class C-s3, d2 <sup>(3)</sup> or better <sup>(4)</sup> From 10m in height and above: no minimum performance
Any other building	More than 18m	Class B-s3, d2 <sup>(2)</sup> or better	From ground level to 18m: class C-s3, d2 <sup>(3)</sup> or better From 18m in height and above: class B-s3, d2 <sup>(2)</sup> or better
	18m or less	Class B-s3, d2 <sup>(2)</sup> or better	No provisions

**NOTES:**

In all cases all the following provisions apply.

- Regulation 7(1A) prohibits the use of relevant metal composite materials in the external walls of all buildings of any height (see paragraphs 10.11 and 10.12).
- The advice in paragraph 10.4 should always be followed.

In addition to the provisions within this table, buildings with a storey 18m or more above ground level should also meet the provisions of paragraph 10.6.

In addition to the provisions within this table, buildings with a storey 11m or more above ground level should also meet the provisions of paragraph 10.7.

1. The restrictions for these buildings apply to all the materials used in the external wall and specified attachments (see paragraphs 10.13 to 10.16 for further guidance).
2. Profiled or flat steel sheet at least 0.5mm thick with an organic coating of no more than 0.2mm thickness is also acceptable.
3. Timber cladding at least 9mm thick is also acceptable.
4. 10m is measured from the top surface of the roof.

## Materials and products

- 10.6** In a **building** with a **storey** 18m or more in **height** (see Diagram D6 in Appendix D) any insulation product, filler material (such as the core materials of metal composite panels, sandwich panels and window spandrel panels but not including gaskets, sealants and similar) etc. used in the construction of an **external wall** should be class A2-s3, d2 or better (see Appendix B). This restriction does not apply to masonry cavity wall construction which complies with Diagram 8.2 in Section 8. Where regulation 7(2) applies, that regulation prevails over all the provisions in this paragraph.
- 10.7** In buildings that include a 'residential' purpose (**purpose groups** 1 and 2) with a **storey** 11m or more in **height** (see Diagram D6 in Appendix D) any insulation product, filler material (such as the core materials of metal composite panels, sandwich panels and window spandrel panels but not including gaskets, sealants and similar) etc. used in the construction of an **external wall** should be class A2-s1, d0 or better (see Appendix B). This restriction does not apply to masonry cavity wall construction which complies with Diagram 8.2 in Section 8. Where regulation 7(2) applies, that regulation prevails over all the provisions in this paragraph.
- 10.8** Best practice guidance for green walls (also called living walls) can be found in *Fire Performance of Green Roofs and Walls*, published by the Department for Communities and Local Government. Where regulation 7(2) applies, that regulation prevails over all the provisions in this paragraph.

## Cavities and cavity barriers

- 10.9** **Cavity barriers** should be provided in accordance with Section 5 in **dwellinghouses** and Section 8 in **flats**.

## Balconies

- 10.10** In **buildings** that include a 'residential' purpose (**purpose groups** 1 and 2) with a **storey** 11m or more in **height** (see Diagram D6 in Appendix D) balconies should meet either of the following conditions.
- a. Only contain materials achieving class A1 or A2-s1, d0, except for any of the following.
    - i. Cavity trays when used between two leaves of masonry.
    - ii. Intumescent and **fire-stopping** materials where the inclusion of the materials is necessary to meet the requirements of Part B of Schedule 1 to the Building Regulations 2010.
    - iii. Membranes.
    - iv. Seals, gaskets, fixings, sealants and backer rods.
    - v. Thermal break materials where the inclusion of the materials is necessary to meet the thermal bridging requirements of Part L of Schedule 1 to the Building Regulations 2010.
    - vi. Any material achieving class A1fl or A2fl-s1 when it forms the top horizontal floor layer of a balcony and is provided with an imperforate substrate under it which extends to the full size of the class A1fl or A2fl-s1 material.
    - vii. Electrical installations.
    - viii. Fibre optic cables.

- b. Achieve both of the following conditions.
- i. Have an imperforate soffit which extends to the full area of the balcony, achieves a minimum REI 30 rating and is constructed of materials achieving class A2-s1, d0 or better.
  - ii. Materials achieving class B-s1, d0 or worse extending beyond the boundary of a single compartment should include a band of material rated class A2-s1, d0 or better, a minimum of 300mm in width centred on that boundary line.

Where regulation 7(2) applies, that regulation prevails over all the provisions in this paragraph.

## Metal composite materials

- 10.11** Regulation 7(1A) prohibits the use of relevant metal composite materials in the external walls of all buildings of any height.
- 10.12** Relevant metal composite materials are defined (in regulation 2(6)(c)) as any panel or sheet, having a thickness of no more than 10mm which is composed of a number of layers two or more of which are made of metal, alloy or metal compound and one or more of which is a substantial layer made of a material having a gross calorific value of more than 35MJ/kg when tested in accordance with **BS EN ISO 1716**. A substantial layer is defined as a layer which is at least 1mm thick or has a mass per unit area of at least 1kg/m<sup>2</sup>.

## Regulation 7(2) and requirement B4

### Materials

- 10.13** Regulation 7(1)(a) requires that materials used in building work are appropriate for the circumstances in which they are used. Regulation 7(2) sets requirements in respect of external walls and specified attachments in relevant buildings.

**NOTE:** Further guidance on regulation 7(1) can be found in HM Government's *Manual to the Building Regulations*.

- 10.14** Regulation 7(2) applies to any building with a storey at least 18m above ground level (as measured in accordance with Diagram D6 in Appendix D) and which contains one or more dwellings; an institution; or a room for residential purposes. It requires that all materials which become part of an external wall or specified attachment achieve class A2-s1, d0 or class A1 in accordance with **BS EN 13501-1**, other than those exempted by regulation 7(3).

**NOTE:** The above includes student accommodation, care homes, sheltered housing, hospitals, dormitories in boarding schools, hotels, hostels and boarding houses. See regulation 7(4) for the definition of relevant buildings.

**NOTE:** Transposition to national class (Table B1) does not apply to the classification in this paragraph.

- 10.15** External walls and specified attachments are defined in regulation 2(6) and these definitions include any parts of the external wall as well as balconies, solar panels and solar shading.
- 10.16** Regulation 7(3) provides an exemption for certain components found in external walls and specified attachments.

## Material change of use

**10.17** Regulations 5(k) and 6(3) provide that, where the use of a **building** is changed such that the **building** becomes a **building** described in regulation 7(4), the construction of the **external walls**, and **specified attachments**, must be investigated and, where necessary, work must be carried out to ensure they only contain materials achieving class A2-s1, d0 or class A1, other than those exempted by regulation 7(3).

## Solar shading devices

**10.18** Regulation 7(2) requires that the **curtain** and or slats of **solar shading devices** in a relevant **building** (as defined in regulation 7(4)) achieve class A1 or A2-s1, d0. The **curtain** of **solar shading devices** cannot be classified as a membrane in accordance with regulation 7(3).

**10.19** **Solar shading devices** installed up to 4.5m above ground level are not required to meet the requirements of regulation 7(2).

## Additional considerations

**10.20** The provisions of regulation 7 apply in addition to requirement B4. Therefore, for **buildings** described in regulation 7(4), the potential impact of any products incorporated into or onto the **external walls** and **specified attachments** should be carefully considered with regard to their number, size, orientation and position.

**10.21** Particular attention is drawn to the following points.

- a. Membranes used as part of the **external wall** construction above ground level should achieve a minimum of class B-s3, d0. Roofing membranes do not need to achieve a minimum of class A2-s1, d0 when used as part of a roof connecting to an **external wall**.
- b. Internal linings should comply with the guidance provided in Section 4.
- c. Any part of a roof should achieve the minimum performance as detailed in Section 12.
- d. As per regulation 7(3), window frames and glass (including laminated glass) are exempted from regulation 7(2). Window spandrel panels and infill panels must comply with regulation 7(2).
- e. Thermal breaks are small elements used as part of the **external wall** construction to restrict thermal bridging. There is no minimum performance for these materials. However, they should not span two **compartments** and should be limited in size to the minimum required to restrict the thermal bridging (the principal insulation layer is not to be regarded as a thermal break).
- f. Regulation 7(2) only applies to **specified attachments**. Shop front signs and similar attachments are not covered by the requirements of regulation 7(2), although attention is drawn to paragraph 10.21g.
- g. While regulation 7(2) applies to materials which become part of an **external wall** or **specified attachment**, consideration should be given to other attachments to the wall which could impact on the risk of fire spread over the wall.
- h. Any material achieving class A1fl or A2fl-s1 in accordance with **BS EN 13501-1** is exempted when it meets both of the following conditions.
  - i. It forms the top horizontal floor layer of a balcony.
  - ii. It is provided with an imperforate substrate under it which extends to the full size of the class A1fl or A2fl-s1 material.

## Section 11: Resisting fire spread from one building to another

**Page 86** **Replace** paragraph 11.7 with the following.

**11.7** Where a **fire resisting external wall** has an external surface material that is worse than class B-s3, d2 and is more than 1mm thick, that part of the wall should be classified as an **unprotected area** equating to half its area (Diagram 11.4).

**Replace** paragraph 11.10 with the following.

**11.10** Exclude **external walls** of stairways in a **protected shaft** when assessing **unprotected areas** (see Diagram 11.5).

**Page 89** **Replace** paragraph 11.16 with the following.

**11.16** Two simple methods are given for calculating the acceptable amount of **unprotected area** in an **external wall** that is a minimum of 1000mm from any point on the **relevant boundary**. More precise methods are described in BRE report BR 187 and may be used instead. When using BR 187 the following radiation intensity at each **unprotected area** should be assumed.

- a. 84kw/m<sup>2</sup> if the **purpose group** of the **building** is 'residential' (**purpose groups** 1 or 2), 'office' (**purpose group** 3) or 'assembly and recreation' (**purpose group** 5) or if the **building** is an open-sided multi-storey car park (**purpose group** 7(b)).
- b. 168kw/m<sup>2</sup> if the **purpose group** of the **building** is 'shop and commercial' (**purpose group** 4), 'industrial' (**purpose group** 6) or 'storage and other non-residential' (**purpose group** 7(a)).

## Section 12: Resisting fire spread over roof coverings

**Page 93** In Table 12.1 **Limitations on roof coverings**, **replace** note 3 with the following.

3. Acceptable on buildings not listed in (2) if both of the following apply.
  - a. Part of the roof has a maximum area of 3m<sup>2</sup> and is a minimum of 1500mm from any similar part.
  - b. The roof between the parts is covered with a material rated class A2-s3, d2 or better.

## Requirement B5: Access and facilities for the fire service

### Intention

**Page 96** **Insert** new sub-paragraph (e).

- e. A facility to store building information for firefighters to complete their tasks.

## Section 13: Vehicle access

**Page 97** **Replace** paragraph 13.1 with the following.

**13.1** For **dwellinghouses**, access for a pumping appliance should be provided to within 45m of all points inside the **dwellinghouse**.

Every elevation to which vehicle access is provided should have a suitable door(s), not less than 750mm wide, giving access to the interior of the **building**.

**Replace** paragraph 13.2 with the following.

**13.2** For **flats**, either of the following provisions should be made.

- a. Provide access for a pumping appliance to within 45m of all points inside each **flat** of a block, measured along the route of the hose. Every elevation to which vehicle access is provided should have a suitable door(s), not less than 750mm wide, giving access to the interior of the **building**. Door(s) should be provided such that there is no more than 60m between each door and/or the end of that elevation (e.g. a 150m elevation would need at least two doors).
- b. Provide fire mains in accordance with paragraphs 13.5 and 13.6.

**Page 98** Paragraph 13.5, **replace** sub-paragraph (b) with the following.

- b. The fire main inlet connection point should be visible from the parking position of the appliance, and meet the provisions in Section 8 of **BS 9990**.



## Section 15: Access to buildings for firefighting personnel – flats

**Page 104** **Replace** paragraph 15.5 with the following.

- 15.5** In buildings where a firefighting shaft is required, a minimum of two firefighting shafts should be provided in either of the following situations.
- a. A building that has both of the following.
    - i. A storey with a floor area of 900m<sup>2</sup> or more.
    - ii. A storey 18m or more above the fire and rescue service vehicle access level.
  - b. A building with a basement storey which is more than 900m<sup>2</sup>.

**Page 106** **Insert** new headings and paragraphs after paragraph 15.16 as follows.

### Evacuation alert systems

- 15.17** In blocks of flats (purpose group 1(a)) with a top storey over 18m above ground level (see Diagram D6 in Appendix D) an evacuation alert system should be provided in accordance with **BS 8629**.

### Secure information boxes

- 15.18** A secure information box provides a secure facility to store information about a building for use by the fire service during an incident.

- 15.19** Blocks of flats (purpose group 1(a)) with a top storey more than 11m above ground level (see Diagram D6 in Appendix D) should be provided with a secure information box.

**NOTE:** Consideration should also be given to other buildings with large, complex or uncommon layouts where the provision of a secure information box may be beneficial.

- 15.20** The box should meet all of the following conditions.
- a. Sized to accommodate all necessary information.
  - b. Easily located and identified by firefighters.
  - c. Secured to resist unauthorised access but readily accessible by firefighters.
  - d. Protected from the weather.
- 15.21** Best practice guidance can be found in Sections 2 to 4 of the *Code of Practice for the Provision of Premises Information Boxes in Residential Buildings* published by the Fire Industry Association (FIA).

## Section 16: Venting of heat and smoke from basements – flats

**Page 108** Replace Diagram 16.1 with the following.

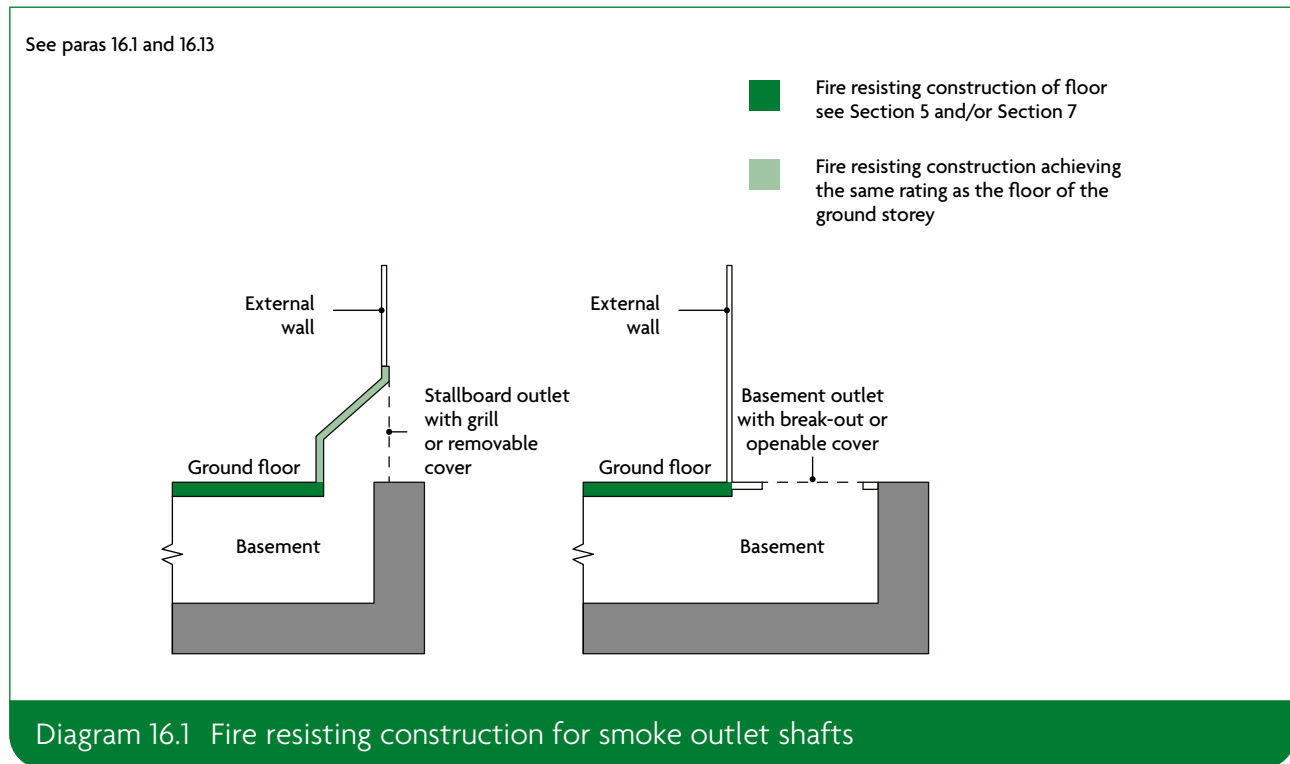

## Appendix A: Key terms

**Page 115** **Insert** the following entry between the definitions of **Corridor access** and **Dead end**.

**Curtain** Part of a solar shading device which is set in motion by the operating system and fulfils the purpose of a blind, awning or shutter.

**Page 118** **Insert** the following entry between the definitions of **Site** and **\*Specified attachment**.

**Solar shading device** A device attached to an external wall for reducing heat gain or controlling visible light within a building by shading or deflecting sunlight.

## Appendix B: Performance of materials, products and structures

**Page 120** **Replace** paragraph B4 with the following.

**B4** Where it is proposed to assess the classification of a product or system in lieu of carrying out a specific test (as in paragraph B1c), this should be done in accordance with the relevant standard for extended application for the test in question and should include details of the test evidence that has been used to support the assessment.

For performance classifications where there is no specific standard for extended application, assessment reports should be produced in accordance with the principles of **BS EN 15725** and should include details of the test evidence that has been used to support the assessment. Further information on best practice is provided in the Passive Fire Protection Forum’s *Guide to Undertaking Technical Assessments of the Fire Performance of Construction Products Based on Fire Test Evidence*.

**NOTE:** Regulation 7(2) limits components used in or on the **external walls** of certain **buildings** to materials achieving class A2-s1, d0 or class A1 (see Section 10). Assessments cannot be used to demonstrate compliance with this requirement.

**Pages 125 to 128** **Replace** paragraph B25 with the following.

**B25** This document uses the European classification system for **fire resistance** set out in **BS EN 13501-2** to **4**; however, there may be some products lawfully on the market using the classification system set out in previous editions. In those situations the alternative classifications given in Table B3 can be used.

In Table B3 **Specific provisions of the test for fire resistance of elements of structure, etc., replace** rows as follows.

1. **Replace** row 2 with the following.

2. <b>Loadbearing wall</b> (for a wall which is also described in any of the following items, the more onerous guidance should be applied).	R see Table B4	See Table B4	Not applicable	Not applicable	Each side separately
---	----------------	--------------	----------------	----------------	----------------------

2. **Replace** row 3b with the following.

b. in upper storey of two storey dwellinghouse (but not over garage or basement)	R 30 and EI 15	30 min	15 min	15 min	From underside <sup>(5)</sup>
--	----------------	--------	--------	--------	-------------------------------

The Building Regulations 2010

3. **Replace** row 5b with the following.

b. any part a minimum of 1000mm from the relevant boundary <sup>(6)</sup>	RE see Table B4 and I 15	See Table B4	See Table B4	15 min	From inside the building
---	--------------------------	--------------	--------------	--------	--------------------------

4. **Replace** row 8 with the following.

<b>8. Protected shafts</b> Excluding any firefighting shaft:					
a. any glazing described in Section 7 diagram 7.2	E 30	Not applicable	30 min	No provision <sup>(8)</sup>	Each side separately
b. any other part between the shaft and a protected lobby/corridor described in Section 7 diagram 7.2	REI 30	30 min	30 min	30 min	Each side separately
c. any part not described in (a) or (b) above.	REI see Table B4	See Table B4	See Table B4	See Table B4	Each side separately

5. **Replace** row 17 with the following.

17. <b>Cavity barrier</b>	E 30 and I 15	Not applicable	30 min	15 min	Each side separately
---------------------------	---------------	----------------	--------	--------	----------------------

## Appendix D: Methods of measurement

**Page 141** **Replace** Diagram D1 with the following.

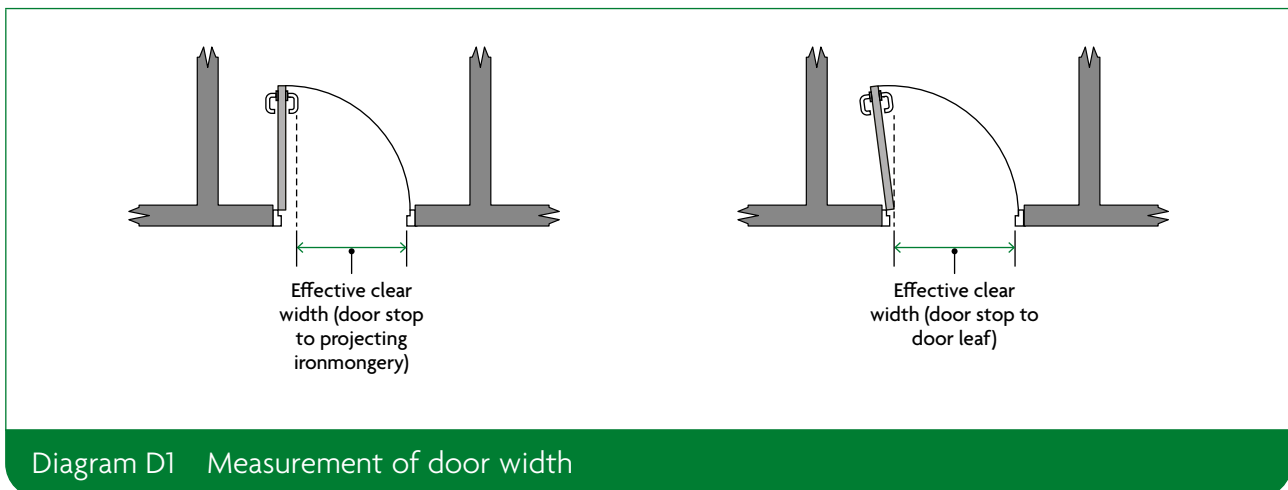

The Building Regulations 2010  
**Approved Document B: Fire safety**  
**Volume 2 – Buildings other than dwellings**  
 2019 edition incorporating the 2020 amendments

**List of amendments**  
 June 2022

**The Building Regulations**

**Notification of work**

**Page iv** **Replace** sub-paragraph (b) with the following.

- b. It is work exempted from the need to notify by regulation 12(6)(a) of, or Schedule 4 to, the Building Regulations.

**Section 0: Approved Document B: Fire safety – buildings other than dwellings**

**Page 5** In Table 0.1 **Classification of purpose groups**, **replace** the ‘Residential (institutional) 2(a)’ row with the following.

Residential (institutional)	2(a)	Hospital, home, school or other similar establishment, where people sleep on the premises. The building may be either of the following: <ul style="list-style-type: none"> <li>• Living accommodation for, or accommodation for the treatment, care or maintenance of, either:                         <ul style="list-style-type: none"> <li>– disabled people with a range of impairments including physical, sensory and cognitive impairments, or mental health conditions</li> <li>– people under the age of 5 years.</li> </ul> </li> <li>• A place of lawful detention.</li> </ul>
-----------------------------	------	---

## Section 1: Fire detection and alarm systems

**Page 11** **Insert** new heading and paragraph after paragraph 1.17 as follows.

### Student accommodation

**1.18** In student residences that are designed and occupied as a block of flats, separate automatic detection should be provided in each self-contained flat where all of the following apply.

- A group of up to six students shares the flat.
- Each flat has its own entrance door.
- The compartmentation principles for flats in Section 7 of Approved Document B Volume 1 have been followed.

Where a total evacuation strategy is adopted, the alarm system should follow the guidance elsewhere in this section.

## Section 2: Design for horizontal escape

**Page 17** **Replace** Diagram 2.4 with the following.

See para 2.12

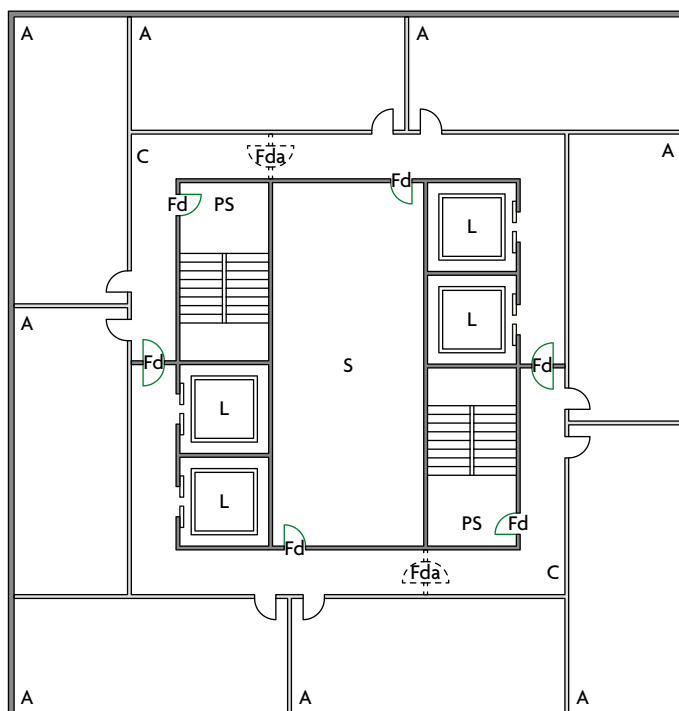

**NOTE:** The doors at both ends of the area marked 'S' should be self-closing fire doorsets unless the area is sub-divided such that any fire in that area will not be able to prejudice both sections of corridor at the same time. If that area is a lift lobby, doors should be provided as shown in Figure 9 in BS 9999.

- L Lift
- S Services, toilets, etc.
- Fd Self-closing E 20 S<sub>a</sub> fire doorsets
- Fda Possible alternative position for fire doorset
- C Corridor off which accommodation opens
- PS Protected stairway
- A Accommodation (e.g. office space – indicative layout shown)

Diagram 2.4 Exits in a central core

**Page 20** Replace Diagram 2.6 with the following.

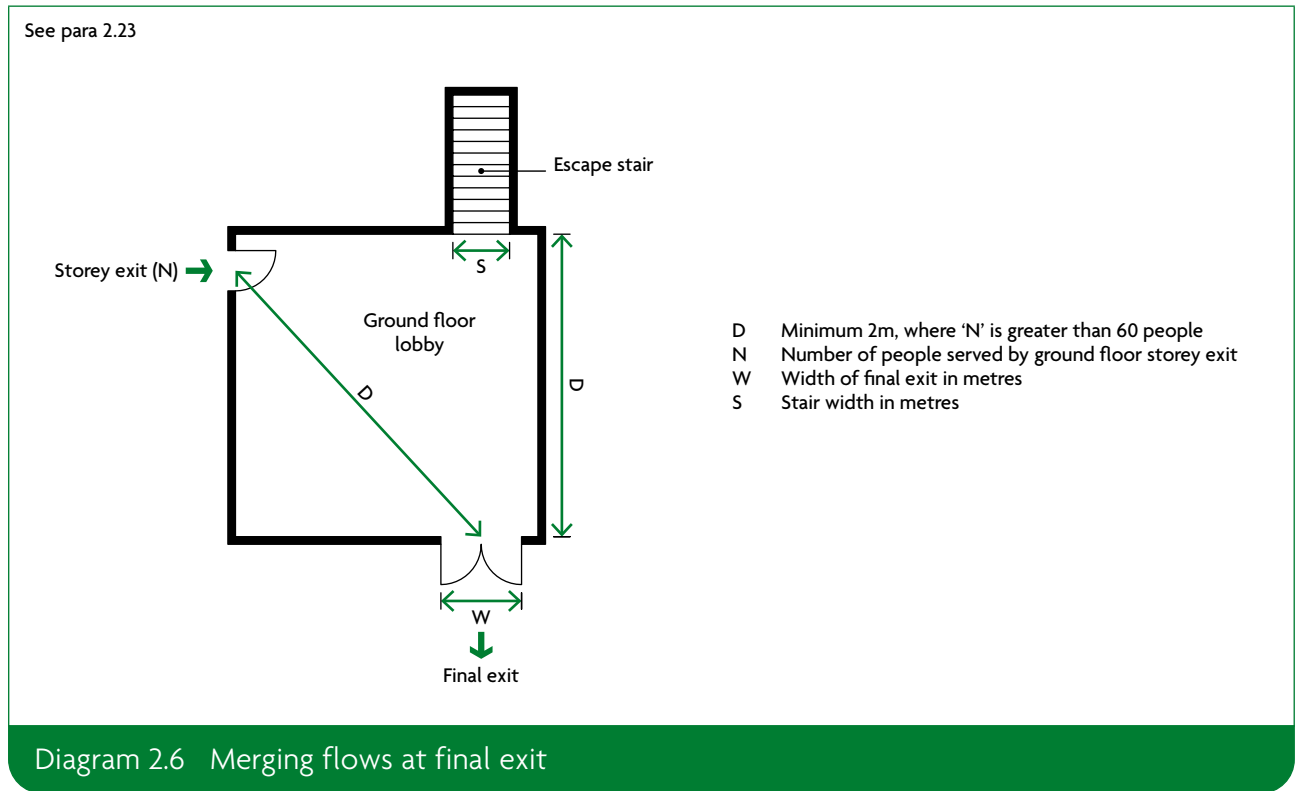

**Page 24** Replace Diagram 2.10 with the following.

See para 2.28

a. 'T' junction with main corridor

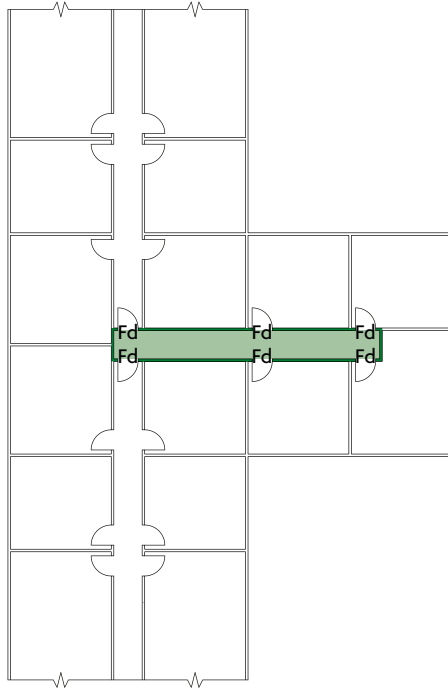

b. Continuation past stairway

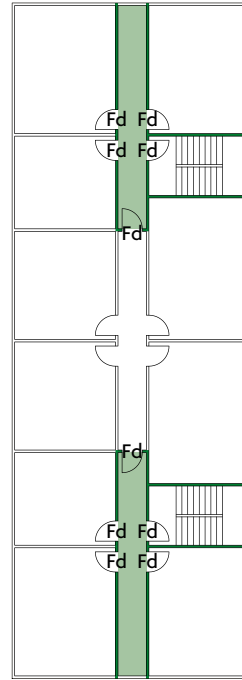

Fd Self-closing fire doorsets

 Protected corridor

Diagram 2.10 Dead-end corridors exceeding 4.5m long



**Page 26** Replace Diagram 2.11 with the following.

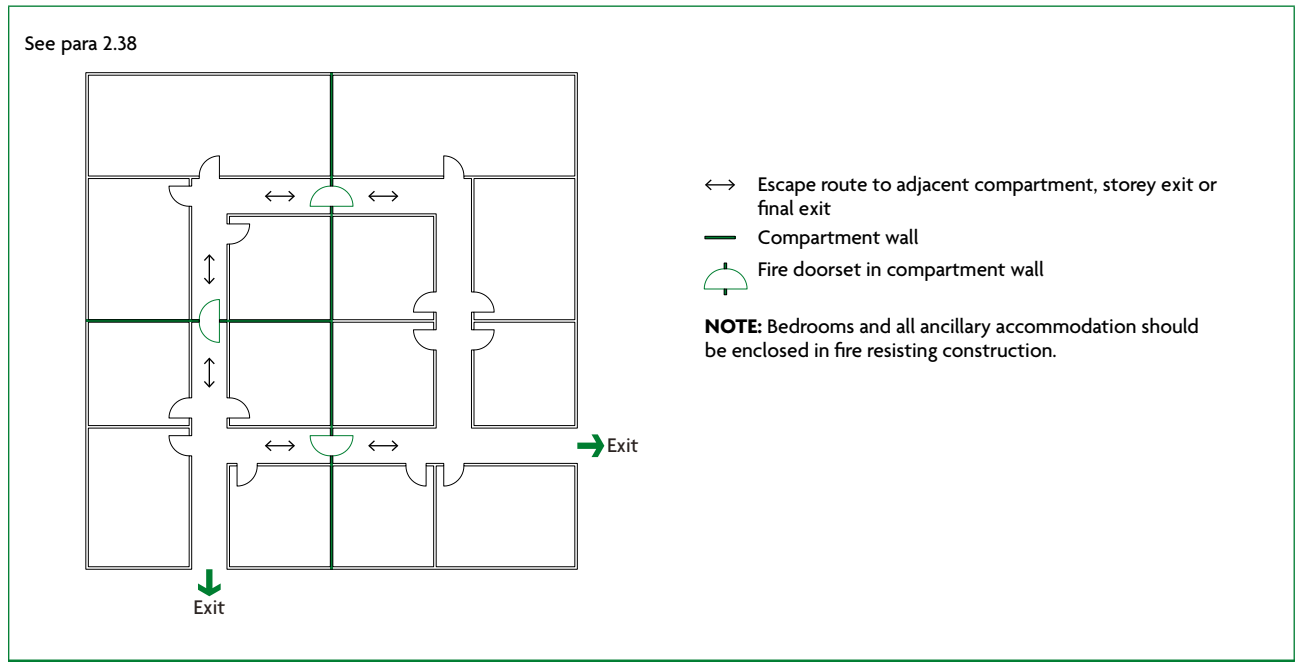
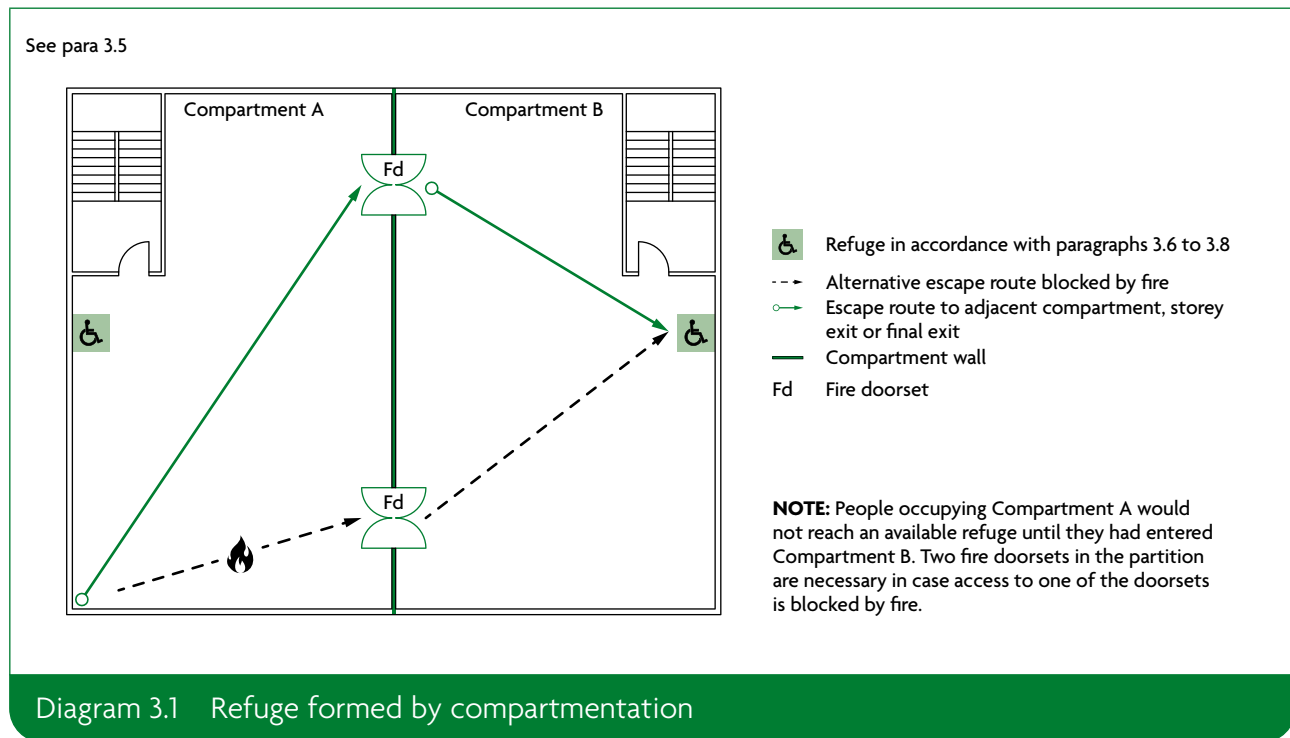

Diagram 2.11 Progressive horizontal evacuation in care homes

## Section 3: Design for vertical escape

**Page 30** Replace Diagram 3.1 with the following.



**Page 35** Replace paragraph 3.20 with the following.

**3.20** Phased evacuation in buildings with a storey over 30m in height introduces the potential for escaping people to impede firefighters entering and operating within the building. This can be addressed by consulting with the fire and rescue service about special management procedures.

In very tall buildings, typically with a storey over 45m in height, physical measures may need to be incorporated, such as by discounting a stair.

Paragraph 3.21, **replace** sub-paragraph (d) with the following.

- d. If there is a storey over 30m above ground level, the building should be protected throughout by an automatic sprinkler system in accordance with Appendix E.

**Page 36** Replace paragraph 3.23 with the following.

**3.23** Every internal escape stair should be a protected stairway (within a fire resisting enclosure). If it is also a protected shaft (i.e. it passes from one compartment to another) or firefighting shaft, additional guidance in Sections 8 and 17 applies.

There is one exception: an unprotected stair (e.g. an accommodation stair) may form part of an internal route to a storey exit or final exit, provided that the distance of travel and the number of people involved are very limited. For example, small premises (Section 4) and raised storage areas (see paragraphs 7.6 and 7.7).

Page 39 Replace Diagram 3.4 with the following.

See para 3.32

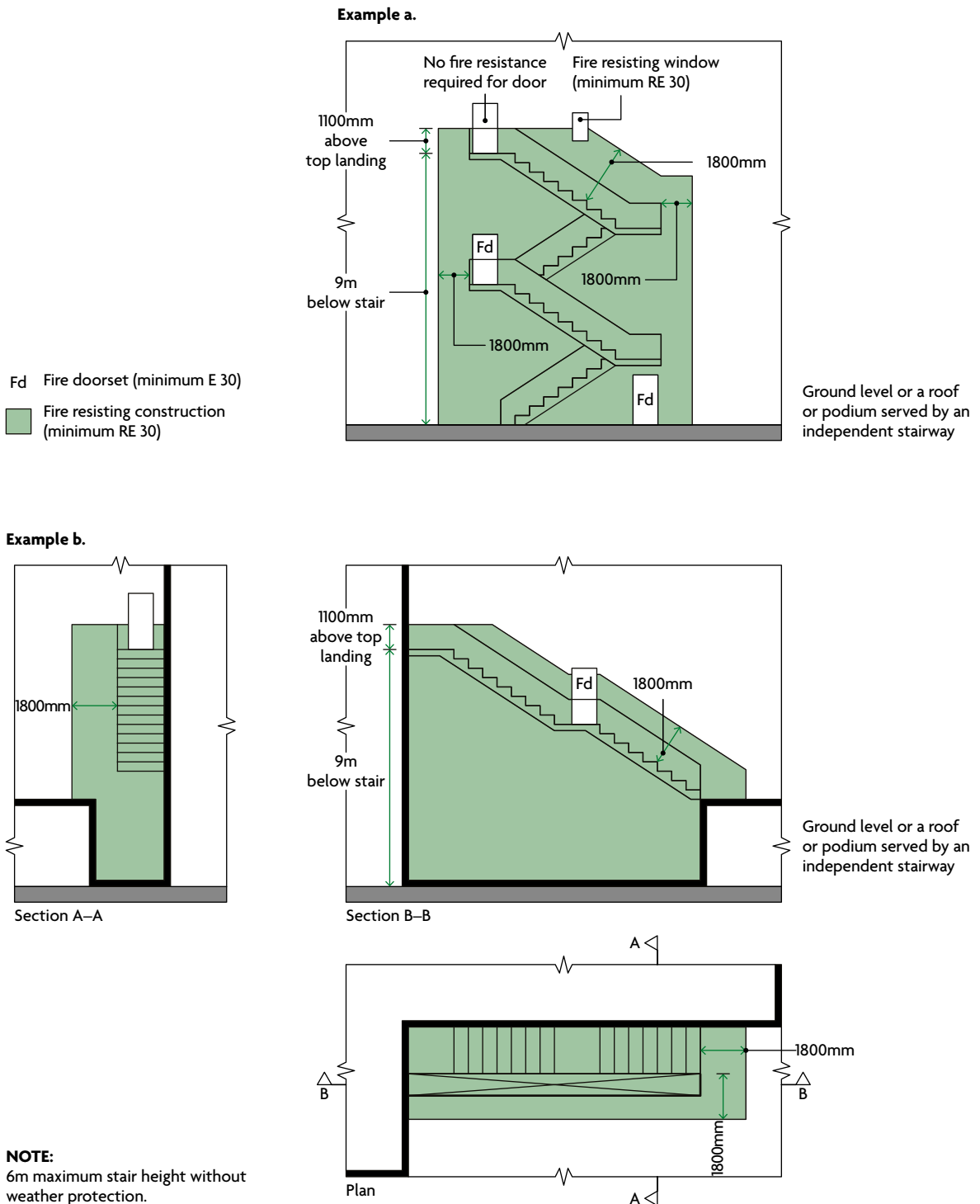

Diagram 3.4 Fire resistance of areas near to external stairs

## Section 5: General provisions

**Page 50** In Table 5.1 **Provisions for escape lighting**, **replace** the ‘Residential’ row with the following.

Residential	All common escape routes <sup>(1)</sup> , except in two storey blocks of flats
-------------	--

## Section 6: Wall and ceiling linings

**Page 57** **Replace** Diagram 6.1 with the following.

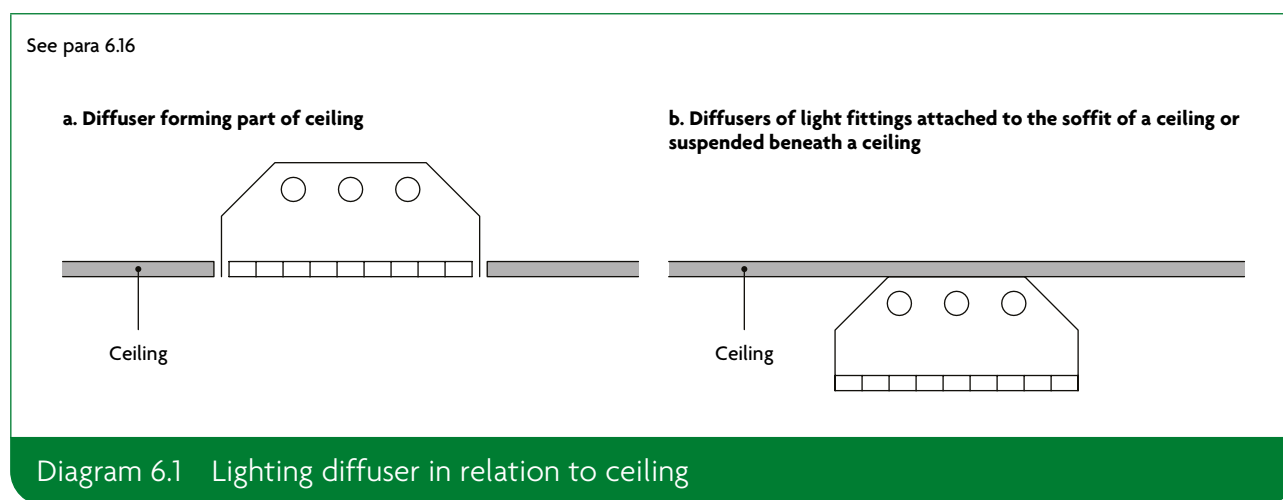

## Section 7: Loadbearing elements of structures

**Page 63** **Replace** the section title with the following.

## Section 7: Loadbearing elements of structure

**Replace** paragraph 7.1 with the following.

**7.1** Elements of structure such as structural frames, beams, columns, loadbearing walls (internal and external), floor structures and gallery structures should have, as a minimum, the fire resistance given in Appendix B, Table B3.

## Section 8: Compartmentation/sprinklers

**Page 67** **Replace** Diagram 8.1 with the following.

See para 8.11

— Compartment floor(s) or wall(s)

**a. Example of compartmentation in an unsprinklered assembly and recreation, shop, or commercial building see paragraph 8.11a**

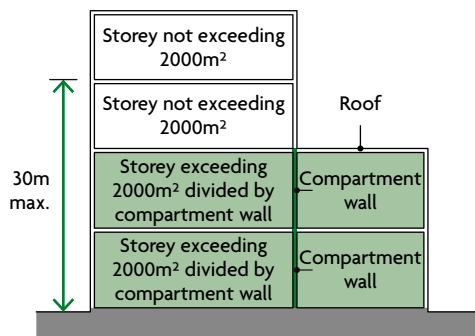

None of the floors in this case would need to be compartment floors, but the two storeys exceeding 2000m<sup>2</sup> would need to be divided into compartments not more than 2000m<sup>2</sup> by compartment walls.

The compartment walls in example (a) do not need to be in one vertical plane.

**c. Shallow basement see paragraph 8.11c**

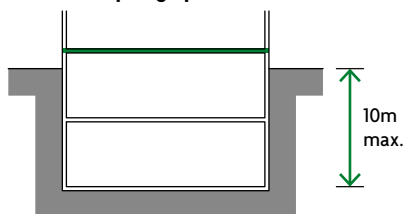

Only the floor of the ground storey need be a compartment floor if the lower basement is at a depth of not more than 10m.

**b. Compartmentation in buildings over 30m see paragraph 8.11b**

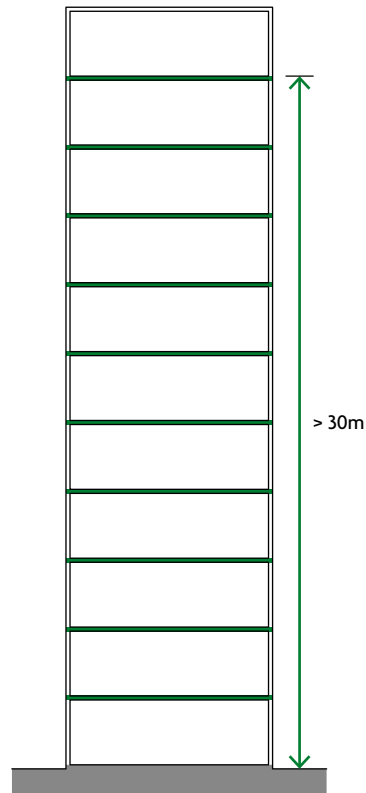

In a building with a top storey over 30m in height all storeys should be separated by compartment floors. For advice on the special conditions in atrium buildings see Annex B of BS 9999.

**d. Deep basement see paragraph 8.11d**

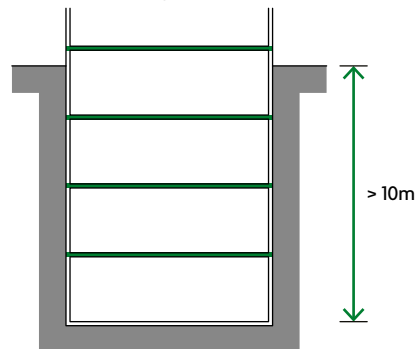

All basement storeys to be separated by compartment floors if any storey is at a depth of more than 10m.

Diagram 8.1 Compartment floors: illustration of guidance in paragraph 8.11

**Page 73** Replace Diagram 8.3 with the following.

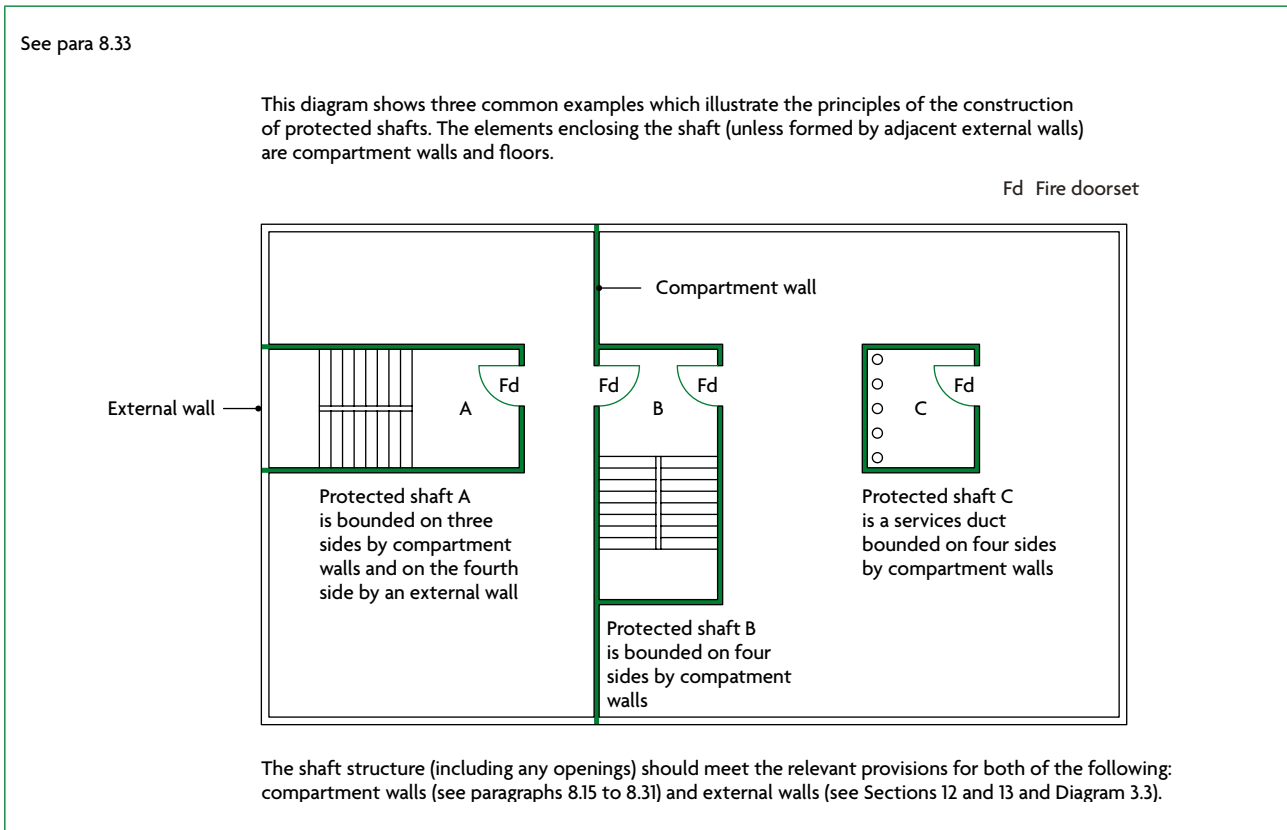

Diagram 8.3 Construction of protected shafts

**Page 74** Replace Diagram 8.4 with the following.

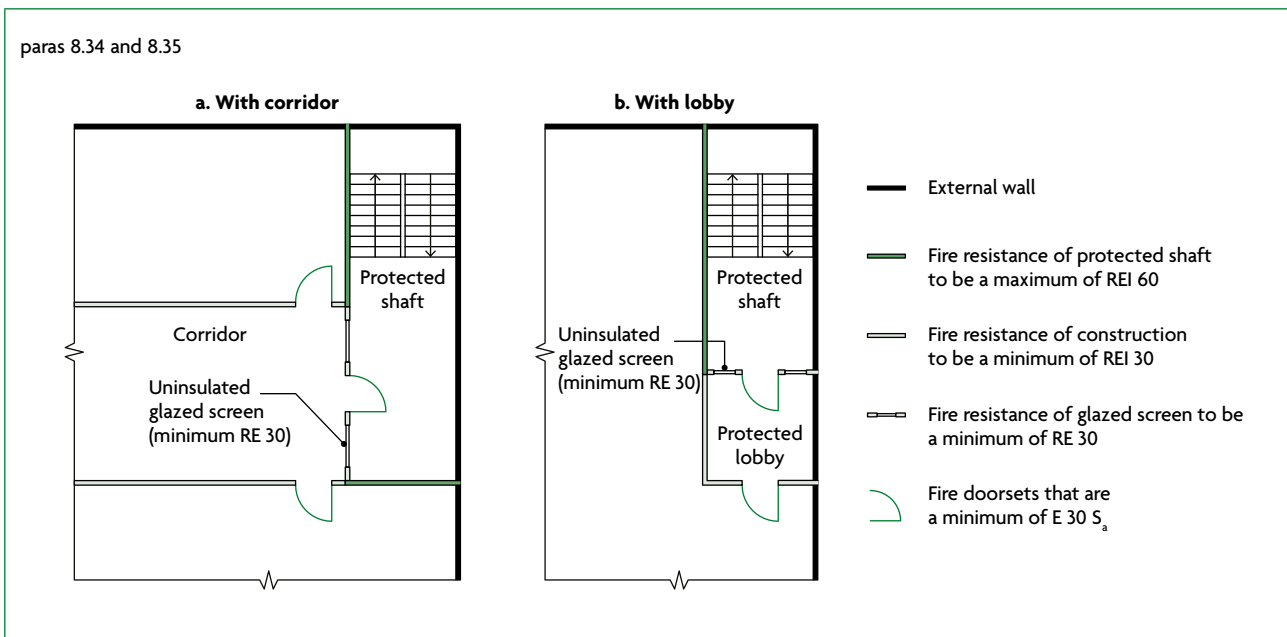

Diagram 8.4 Uninsulated glazed screen separating protected shaft from lobby or corridor

## Section 9: Cavities

**Page 77** **Replace** subheading before paragraph 9.3 with the following.

### Junctions and edges of cavities

**Page 78** **Replace** Diagram 9.3 with the following.

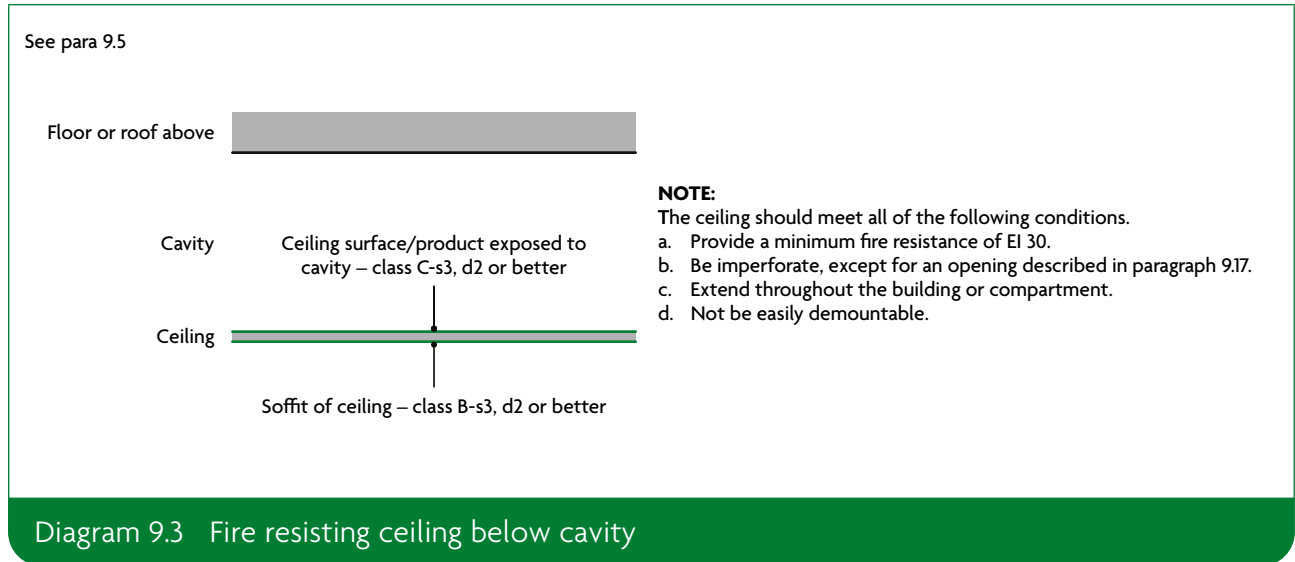

**Page 80** **Replace** the first sentence of paragraph 9.12 with the following.

If the undivided area exceeds 40m in any direction, there is no limit to its size if all of the following conditions are met.

## Section 10: Protection of openings and fire-stopping

**Page 82** **Replace** paragraph 10.1 with the following.

**10.1** Every joint, imperfect fit and opening for services through a fire-separating element should be sealed with fire-stopping to ensure the fire resistance of the element is not impaired. Fire-stopping delays the spread of fire and, generally, the spread of smoke as well.

**Page 83** **Replace** Diagram 10.1 with the following.

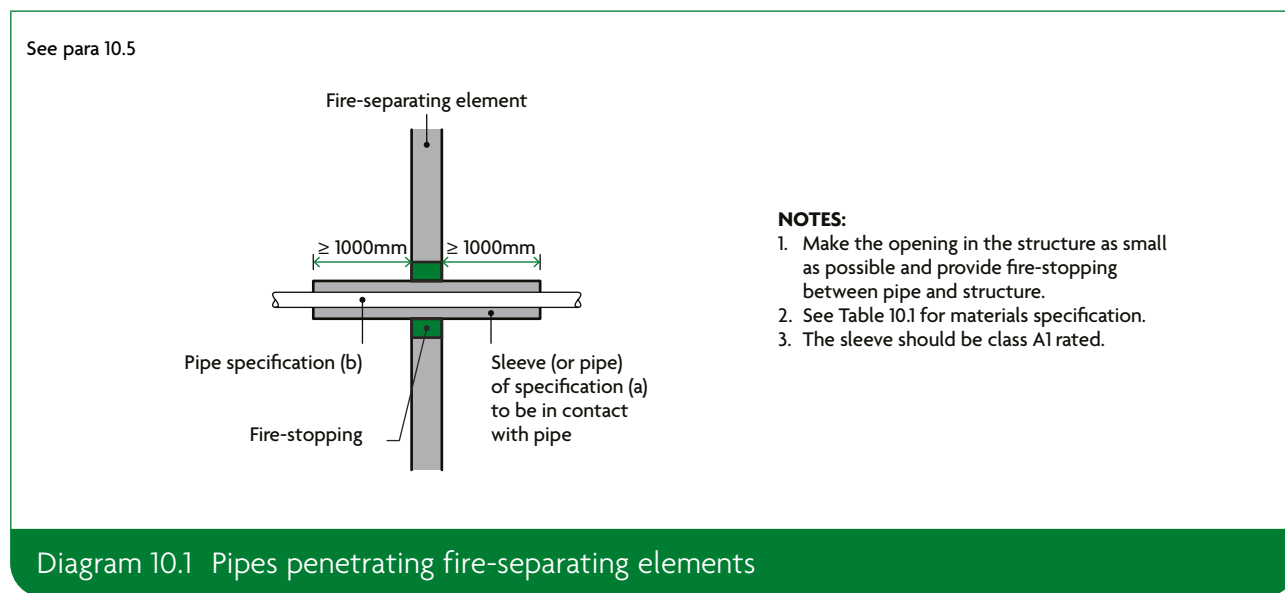

Diagram 10.1 Pipes penetrating fire-separating elements

In Table 10.1 **Maximum nominal internal diameter of pipes passing through a compartment wall/floor**, **replace** the table title with the following.

**Table 10.1 Maximum nominal internal diameter of pipes passing through a fire-separating element**

**Page 84** **Replace** paragraph 10.12 with the following.

**10.12** If air handling ducts pass through **fire-separating elements**, the fire performance of the elements should be maintained using one or more of the following four methods. In most ductwork systems, a combination of the four methods is best.

- a. Method 1 – thermally activated **fire dampers**.
- b. Method 2 – **fire resisting** enclosures.
- c. Method 3 – protection using **fire resisting** ductwork.
- d. Method 4 – automatically activated **fire and smoke dampers** triggered by smoke detectors.



## Section 11: Special provisions for car parks

**Page 89** Paragraph 11.2, **replace** sub-paragraph (b) with the following.

- b. Each storey is naturally ventilated by permanent openings at each car parking level. The aggregate vent area is a minimum of 1/20 of that level's floor area, at least half of which is provided equally by two opposite walls (1/80 on each side). The remaining free area can be distributed wherever possible.

## Requirement B4: External fire spread

**Pages 91 and 92** **Replace** the requirement text with the following.

Requirement	
<i>Requirement</i>	<i>Limits on application</i>
<b>External fire spread</b>	
<p><b>B4.</b> (1) The external walls of the building shall adequately resist the spread of fire over the walls and from one building to another having regard to the height, use and position of the building.</p> <p>(2) The roof of the building shall adequately resist the spread of fire over the roof and from one building to another, having regard to the use and position of the building.</p>	
Regulation	
<b>Regulation 7 – Materials and workmanship</b>	
<p>(1) Building work shall be carried out—</p> <ul style="list-style-type: none"> <li>(a) with adequate and proper materials which—                             <ul style="list-style-type: none"> <li>(i) are appropriate for the circumstances in which they are used,</li> <li>(ii) are adequately mixed or prepared, and</li> <li>(iii) are applied, used or fixed so as adequately to perform the functions for which they are designed; and</li> </ul> </li> <li>(b) in a workmanlike manner.</li> </ul> <p>(1A) Building work shall be carried out so that relevant metal composite material does not become part of an external wall, or specified attachment, of any building.</p>	

**Regulation *continued***

- (2) Subject to paragraph (3), building work shall be carried out so that materials which become part of an external wall, or specified attachment, of a relevant building are of European Classification A2-s1, d0 or A1 (classified in accordance with the reaction to fire classification).
- (3) Paragraph (2) does not apply to—
- (a) cavity trays when used between two leaves of masonry;
  - (b) any part of a roof (other than any part of a roof which falls within paragraph (iv) of regulation 2(6)) if that part is connected to an external wall;
  - (c) door frames and doors;
  - (d) electrical installations;
  - (da) fibre optic cables;
  - (e) insulation and water proofing materials used below ground level or up to 300mm above that level;
  - (f) intumescent and fire stopping materials where the inclusion of the materials is necessary to meet the requirements of Part B of Schedule 1;
  - (g) membranes;
  - (h) seals, gaskets, fixings, sealants and backer rods;
  - (ha) components associated with a solar shading device, excluding components whose primary function is to provide shade or deflect sunlight, such as the awning, curtain or slats;
  - (i) thermal break materials where the inclusion of the materials is necessary to meet the thermal bridging requirements of Part L of Schedule 1;
  - (j) window frames and glass; or
  - (k) materials which form the top horizontal floor layer of a balcony which are of European Classification A1fl or A2fl-s1 (classified in accordance with the reaction to fire classification) provided that the entire layer has an imperforate substrate under it.
- (4) In this regulation—
- (a) a “relevant building” means a building with a storey (not including roof-top plant areas or any storey consisting exclusively of plant rooms) at least 18 metres above ground level and which—
    - (i) contains one or more dwellings;
    - (ii) contains an institution; or
    - (iii) contains a room for residential purposes; and
  - (b) “above ground level” in relation to a storey means above ground level when measured from the lowest ground level adjoining the outside of a building to the top of the floor surface of the storey.

## Section 12: Resisting fire spread over external walls

**Pages 94 to 97** Replace Section 12 with the following.

# Section 12: Resisting fire spread over external walls

## Introduction

**12.1** The **external wall** of a **building** should not provide a medium for fire spread if that is likely to be a risk to health and safety. Combustible materials and **cavities** in **external walls** and attachments to them can present such a risk, particularly in tall **buildings**. The guidance in this section is designed to reduce the risk of fire spread as well as the risk of ignition from flames coming from adjacent **buildings**.

## Fire resistance

**12.2** This section provides guidance on resisting fire spread over **external walls**; however, it does not deal with **fire resistance** of **external walls**. An **external wall** may need **fire resistance** to meet the provisions of Section 3 (Design for vertical escape), Section 7 (Loadbearing elements of structure), Section 13 (Resisting fire spread from one building to another) or Section 17 (Access to buildings for firefighting personnel).

## Combustibility of external walls

**12.3** The **external walls** of **buildings** other than those described in regulation 7(4) of the Building Regulations should achieve either of the following.

- a. Follow the provisions given in paragraphs 12.5 to 12.10, which provide guidance on all of the following.
  - i. External surfaces.
  - ii. Materials and products.
  - iii. **Cavities** and **cavity barriers**.
- b. Meet the performance criteria given in BRE report BR 135 for **external walls** using full-scale test data from **BS 8414-1** or **BS 8414-2**.

**12.4** In relation to **buildings** of any **height** or use, consideration should be given to the choice of materials (including their extent and arrangement) used for the **external wall**, or attachments to the wall (e.g. balconies, etc.), to reduce the risk of fire spread over the wall.

**External surfaces**

**12.5** The external surfaces (i.e. outermost external material) of external walls should comply with the provisions in Table 12.1. The provisions in Table 12.1 apply to each wall individually in relation to its proximity to the relevant boundary.

**Table 12.1 Reaction to fire performance of external surface of walls**

Building type	Building height	Less than 1000mm from the relevant boundary	1000mm or more from the relevant boundary
'Relevant buildings' as defined in regulation 7(4) (see paragraph 12.15)		Class A2-s1, d0 <sup>(1)</sup> or better	Class A2-s1, d0 <sup>(1)</sup> or better
All 'residential' purpose groups (purpose groups 1 and 2)	More than 11m	Class A2-s1, d0 <sup>(2)</sup> or better	Class A2-s1, d0 <sup>(2)</sup> or better
	11m or less	Class B-s3, d2 <sup>(2)</sup> or better	No provisions
Assembly and recreation	More than 18m	Class B-s3, d2 <sup>(2)</sup> or better	From ground level to 18m: class C-s3, d2 <sup>(3)</sup> or better From 18m in height and above: class B-s3, d2 <sup>(2)</sup> or better
	18m or less	Class B-s3, d2 <sup>(2)</sup> or better	Up to 10m above ground level: class C-s3, d2 <sup>(3)</sup> or better Up to 10m above a roof or any part of the building to which the public have access: class C-s3, d2 <sup>(3)</sup> or better <sup>(4)</sup> From 10m in height and above: no minimum performance
Any other building	More than 18m	Class B-s3, d2 <sup>(2)</sup> or better	From ground level to 18m: class C-s3, d2 <sup>(3)</sup> or better From 18m in height and above: class B-s3, d2 <sup>(2)</sup> or better
	18m or less	Class B-s3, d2 <sup>(2)</sup> or better	No provisions

**NOTES:**

In all cases all the following provisions apply.

- Regulation 7(1A) prohibits the use of relevant metal composite materials in the external walls of all buildings of any height (see paragraphs 12.12 and 12.13).
- The advice in paragraph 12.4 should always be followed.

In addition to the provisions within this table, buildings with a storey 18m or more above ground level should also meet the provisions of paragraph 12.6.

In addition to the provisions within this table, buildings with a storey 11m or more above ground level should also meet the provisions of paragraph 12.7.

1. The restrictions for these buildings apply to all the materials used in the external wall and specified attachments (see paragraphs 12.14 to 12.17 for further guidance).
2. Profiled or flat steel sheet at least 0.5 mm thick with an organic coating of no more than 0.2mm thickness is also acceptable.
3. Timber cladding at least 9mm thick is also acceptable.
4. 10m is measured from the top surface of the roof.

## Materials and products

- 12.6** In a **building** with a **storey** 18m or more in **height** (see Diagram D6 in Appendix D) any insulation product, filler material (such as the core materials of metal composite panels, sandwich panels and window spandrel panels but not including gaskets, sealants and similar) etc. used in the construction of an **external wall** should be class A2-s3, d2 or better (see Appendix B). This restriction does not apply to masonry cavity wall construction which complies with Diagram 9.2 in Section 9. Where regulation 7(2) applies, that regulation prevails over all the provisions in this paragraph.
- 12.7** In buildings that include a 'residential' purpose (**purpose groups** 1 and 2) with a **storey** 11m or more in **height** (see Diagram D6 in Appendix D) any insulation product, filler material (such as the core materials of metal composite panels, sandwich panels and window spandrel panels but not including gaskets, sealants and similar) etc. used in the construction of an **external wall** should be class A2-s1, d0 or better (see Appendix B). This restriction does not apply to masonry cavity wall construction which complies with Diagram 9.2 in Section 9. Where regulation 7(2) applies, that regulation prevails over all the provisions in this paragraph.
- 12.8** Best practice guidance for green walls (also called living walls) can be found in *Fire Performance of Green Roofs and Walls*, published by the Department for Communities and Local Government. Where regulation 7(2) applies, that regulation prevails over all the provisions in this paragraph.

## Cavities and cavity barriers

- 12.9** **Cavity barriers** should be provided in accordance with Section 9.
- 12.10** In the case of an **external wall** construction of a **building** which, by virtue of paragraph 9.10d (external cladding system with a masonry or concrete inner leaf), is not subject to the provisions of Table 9.1, the surfaces which face into **cavities** should also meet the provisions of Table 12.1 and provisions in Section 9, but where regulation 7(2) applies, that regulation prevails over the guidance provided in Table 12.1 and Section 9.

## Balconies

- 12.11** In **buildings** that include a 'residential' purpose (**purpose groups** 1 and 2) with a **storey** 11m or more in **height** (see Diagram D6 in Appendix D) balconies should meet either of the following conditions.
- a. Only contain materials achieving class A1 or A2-s1, d0, except for any of the following.
    - i. Cavity trays when used between two leaves of masonry.
    - ii. Intumescent and **fire-stopping** materials where the inclusion of the materials is necessary to meet the requirements of Part B of Schedule 1 to the Building Regulations 2010.
    - iii. Membranes.
    - iv. Seals, gaskets, fixings, sealants and backer rods.
    - v. Thermal break materials where the inclusion of the materials is necessary to meet the thermal bridging requirements of Part L of Schedule 1 to the Building Regulations 2010.

- vi. Any material achieving class A1fl or A2fl-s1 when it forms the top horizontal floor layer of a balcony and is provided with an impermeate substrate under it which extends to the full size of the class A1fl or A2fl-s1 material.
  - vii. Electrical installations.
  - viii. Fibre optic cables.
- b. Achieve both of the following conditions.
- i. Have an impermeate soffit which extends to the full area of the balcony, achieves a minimum REI 30 rating and is constructed of materials achieving class A2-s1, d0 or better.
  - ii. Materials achieving class B-s1, d0 or worse extending beyond the boundary of a single compartment should include a band of material rated class A2-s1, d0 or better, a minimum of 300mm in width centred on that boundary line.

Where regulation 7(2) applies, that regulation prevails over all the provisions in this paragraph.

## Metal composite materials

**12.12** Regulation 7(1A) prohibits the use of relevant metal composite materials in the **external walls** of all **buildings** of any **height**.

**12.13** Relevant metal composite materials are defined (in regulation 2(6)(c)) as any panel or sheet, having a thickness of no more than 10mm which is composed of a number of layers two or more of which are made of metal, alloy or metal compound and one or more of which is a substantial layer made of a material having a gross calorific value of more than 35MJ/kg when tested in accordance with **BS EN ISO 1716**. A substantial layer is defined as a layer which is at least 1mm thick or has a mass per unit area of at least 1kg/m<sup>2</sup>.

## Regulation 7(2) and requirement B4

### Materials

**12.14** Regulation 7(1)(a) requires that materials used in building work are appropriate for the circumstances in which they are used. Regulation 7(2) sets requirements in respect of **external walls** and **specified attachments** in relevant **buildings**.

**NOTE:** Further guidance on regulation 7(1) can be found in HM Government's *Manual to the Building Regulations*.

**12.15** Regulation 7(2) applies to any **building** with a **storey** at least 18m above ground level (as measured in accordance with Diagram D6 in Appendix D) and which contains one or more **dwellings**; an institution; or a **room** for residential purposes. It requires that all materials which become part of an **external wall** or **specified attachment** achieve class A2-s1, d0 or class A1 in accordance with **BS EN 13501-1**, other than those exempted by regulation 7(3).

**NOTE:** The above includes student accommodation, care homes, **sheltered housing**, hospitals, dormitories in boarding **schools**, hotels, hostels and boarding houses. See regulation 7(4) for the definition of relevant **buildings**.

**NOTE:** Transposition to national class (Table B1) does not apply to the classification in this paragraph.

**12.16** **External walls** and **specified attachments** are defined in regulation 2(6) and these definitions include any parts of the **external wall** as well as balconies, solar panels and solar shading.

**12.17** Regulation 7(3) provides an exemption for certain components found in **external walls** and **specified attachments**.

## Material change of use

**12.18** Regulations 5(k) and 6(3) provide that, where the use of a **building** is changed such that the **building** becomes a **building** described in regulation 7(4), the construction of the **external walls**, and **specified attachments**, must be investigated and, where necessary, work must be carried out to ensure they only contain materials achieving class A2-s1, d0 or class A1, other than those exempted by regulation 7(3).

## Solar shading devices

**12.19** Regulation 7(2) requires that the **curtain** and or slats of **solar shading devices** in a relevant **building** (as defined in regulation 7(4)) achieve class A1 or A2-s1, d0. The **curtain** of **solar shading devices** cannot be classified as a membrane in accordance with regulation 7(3).

**12.20** **Solar shading devices** installed up to 4.5m above ground level are not required to meet the requirements of regulation 7(2).

## Additional considerations

**12.21** The provisions of regulation 7 apply in addition to requirement B4. Therefore, for **buildings** described in regulation 7(4), the potential impact of any products incorporated into or onto the **external walls** and **specified attachments** should be carefully considered with regard to their number, size, orientation and position.

**12.22** Particular attention is drawn to the following points.

- a. Membranes used as part of the **external wall** construction above ground level should achieve a minimum of class B-s3, d0. Roofing membranes do not need to achieve a minimum of class A2-s1, d0 when used as part of a roof connecting to an **external wall**.
- b. Internal linings should comply with the guidance provided in Section 4.
- c. Any part of a roof should achieve the minimum performance as detailed in Section 12.
- d. As per regulation 7(3), window frames and glass (including laminated glass) are exempted from regulation 7(2). Window spandrel panels and infill panels must comply with regulation 7(2).
- e. Thermal breaks are small elements used as part of the **external wall** construction to restrict thermal bridging. There is no minimum performance for these materials. However, they should not span two **compartments** and should be limited in size to the minimum required to restrict the thermal bridging (the principal insulation layer is not to be regarded as a thermal break).
- f. Regulation 7(2) only applies to **specified attachments**. Shop front signs and similar attachments are not covered by the requirements of regulation 7(2), although attention is drawn to paragraph 12.22g.
- g. While regulation 7(2) applies to materials which become part of an **external wall** or **specified attachment**, consideration should be given to other attachments to the wall which could impact on the risk of fire spread over the wall.
- h. Any material achieving class A1fl or A2fl-s1 in accordance with **BS EN 13501-1** is exempted when it meets both of the following conditions.
  - i. It forms the top horizontal floor layer of a balcony.
  - ii. It is provided with an imperforate substrate under it which extends to the full size of the class A1fl or A2fl-s1 material.

## Section 13: Resisting fire spread from one building to another

**Page 101** **Replace** paragraph 13.7 with the following.

**13.7** Where a **fire resisting external wall** has an external surface material that is worse than class B-s3, d2 and is more than 1mm thick, that part of the wall should be classified as an **unprotected area** equating to half its area (Diagram 13.4).

**Replace** paragraph 13.9 with the following.

**13.9** Exclude **external walls** of stairways in a **protected shaft** when assessing **unprotected areas** (see Diagram 3.3).

**Page 104** **Replace** paragraph 13.16 with the following.

**13.16** Two simple methods are given for calculating the acceptable amount of **unprotected area** in an **external wall** that is a minimum of 1000mm from any point on the **relevant boundary**. More precise methods are described in BRE report BR 187 and may be used instead. When using BR 187 the following radiation intensity at each **unprotected area** should be assumed.

- a. 84kw/m<sup>2</sup> if the **purpose group** of the **building** is 'residential' (**purpose groups** 1 or 2), 'office' (**purpose group** 3) or 'assembly and recreation' (**purpose group** 5) or if the **building** is an open-sided multi-storey car park (**purpose group** 7(b)).
- b. 168kw/m<sup>2</sup> if the **purpose group** of the **building** is 'shop and commercial' (**purpose group** 4), 'industrial' (**purpose group** 6) or 'storage and other non-residential' (**purpose group** 7(a)).

## Section 14: Resisting fire spread over roof coverings

**Page 106** **Replace** paragraph 14.7 with the following.

**14.7** Other than for the purposes of Diagram 8.2, polycarbonate or uPVC **rooflights** achieving a minimum rating of class C-s3, d2 can be regarded as having a B<sub>ROOF</sub>(t4) classification.

**Page 107** In Table 14.1 **Limitations on roof coverings**, **replace** note 3 with the following.

3. Acceptable on buildings not listed in (2) if both of the following apply.
  - a. Part of the roof has a maximum area of 3m<sup>2</sup> and is a minimum of 1500mm from any similar part.
  - b. The roof between the parts is covered with a material rated class A2-s3, d2 or better.

## Section 15: Vehicle access

**Page 110** **Replace** the first sentence of paragraph 15.1 with the following.

**15.1** For small **buildings** (up to 2000m<sup>2</sup>, with a top **storey** that is a maximum of 11m above ground level), vehicle access for a pump appliance should be provided to whichever is the less onerous of the following.



Page 111 **Replace** Diagram 15.1 with the following.

See para 15.1

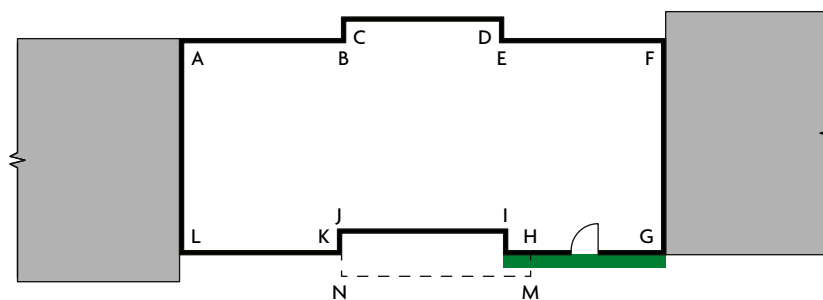
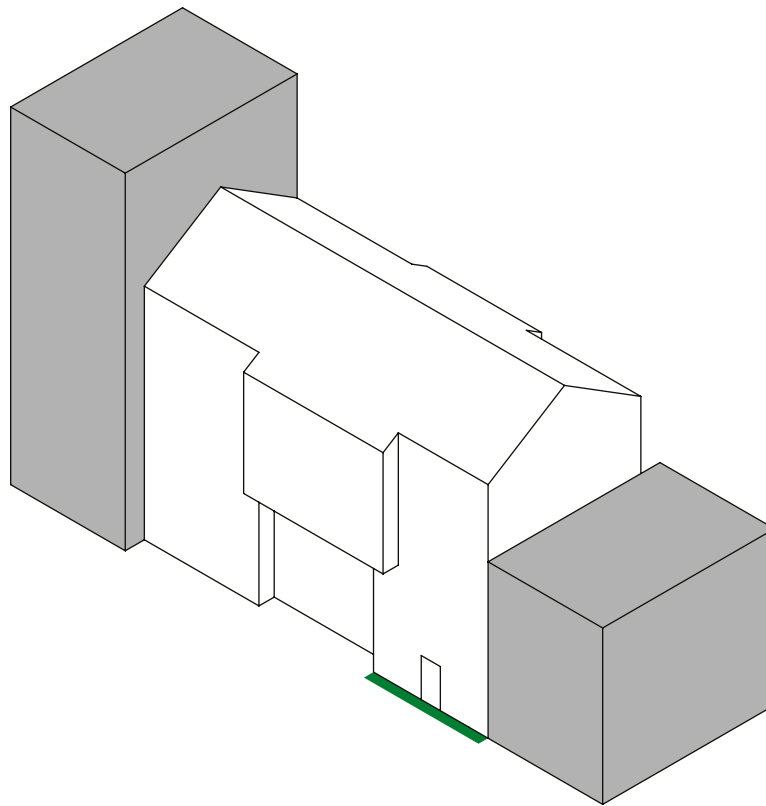

Plan of building AFGL where AL and FG are walls in common with other buildings.

The footprint of the building is the maximum aggregate plan perimeter found by the vertical projection of any overhanging storey onto a ground storey (i.e. ABCDEFGHMNKL).

The perimeter of the building for the purposes of Table 15.1 is the sum of the lengths of the two external walls, taking account of the footprint, i.e. (A to B to C to D to E to F) + (G to H to M to N to K to L).

If the dimensions of the building are such that Table 15.1 requires vehicle access, the green shaded area illustrates one possible example of 15% of the perimeter. Note: There should be a door into the building in this length (see paragraph 15.3).

If the building does not have walls in common with other buildings, the lengths AL and FG would be included in the perimeter.

Diagram 15.1 Example of building footprint and perimeter

**Page 113** Replace Diagram 15.2 with the following.

See paras 15.8 and 15.9

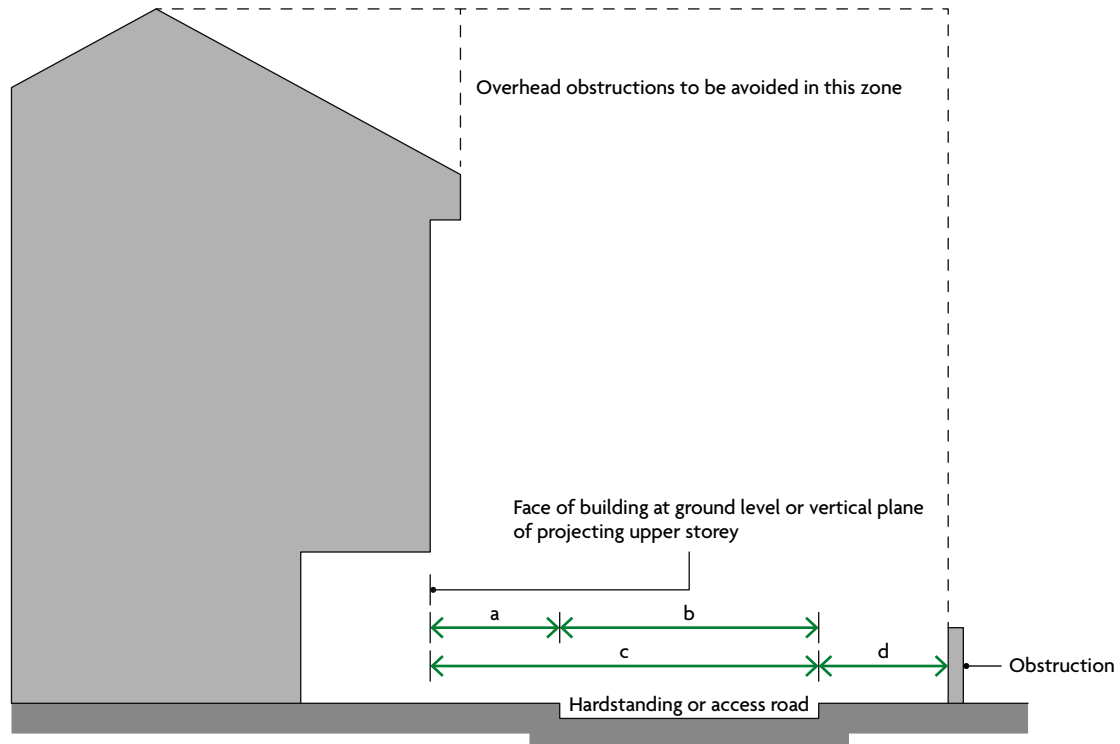

	Type of appliance	
	Turntable ladder dimension (m)	Hydraulic platform dimension (m)
a. Maximum distance of near edge of hardstanding from building	4.9	2.0
b. Minimum width of hardstanding	5.0	5.5
c. Minimum distance of further edge of hardstanding from building	10.0	7.5
d. Minimum width of unobstructed space (for swing of appliance platform)	N/A	2.2

**NOTES:**

1. Hardstanding for high reach appliances should be as level as possible and should have a maximum gradient of 1 in 12.
2. Fire appliances are not standardised. Some fire services have appliances with a greater weight or different size. In consultation with the fire and rescue service, the building control body should adopt the relevant dimensions and ground loading capacity.

Diagram 15.2 Relationship between building and hardstanding/access roads for high reach fire appliances

## Section 18: Venting of heat and smoke from basements

**Page 123** **Replace** Diagram 18.1 with the following.

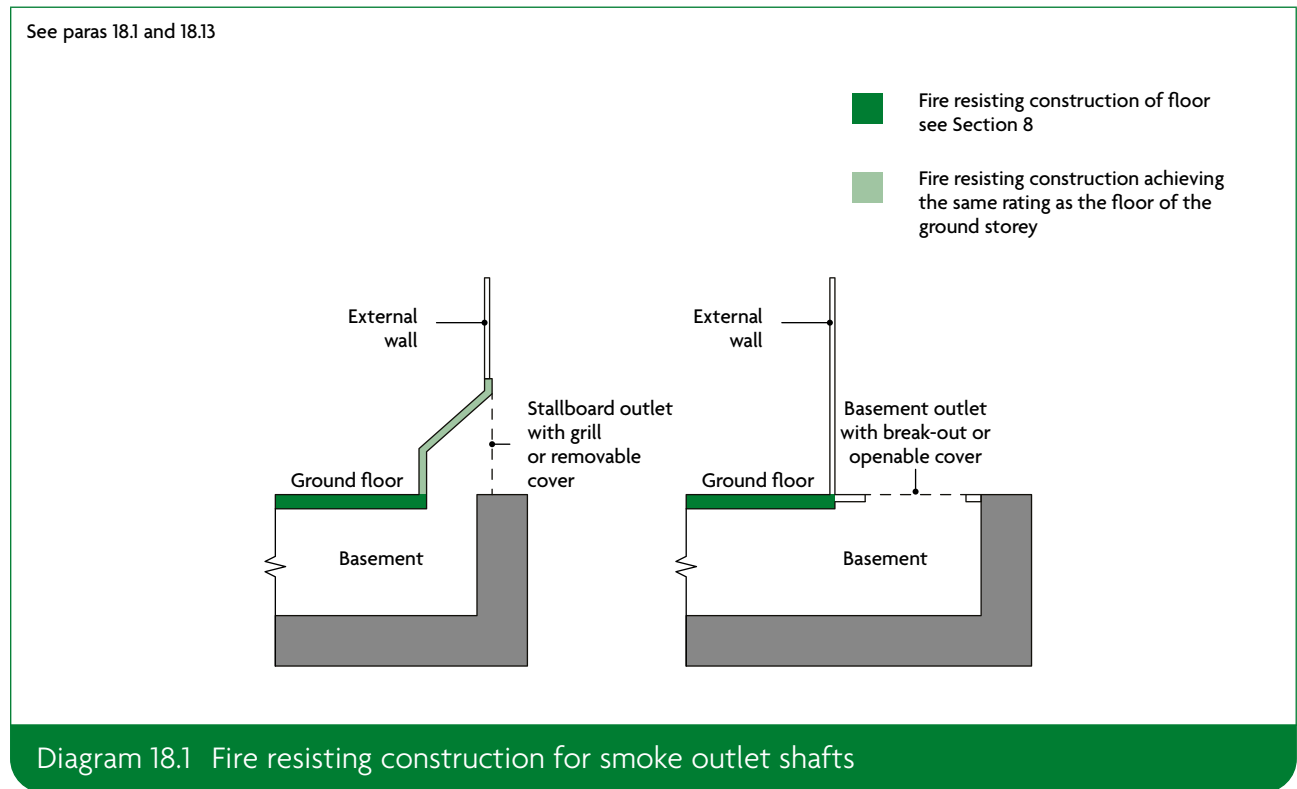

## Appendix A: Key terms

**Page 130** **Insert** the following entry between the definitions of **Corridor access** and **Dead end**.

**Curtain** Part of a solar shading device which is set in motion by the operating system and fulfils the purpose of a blind, awning or shutter.

**Page 133** **Insert** the following entry between the definitions of **Site** and **\*Specified attachment**.

**Solar shading device** A device attached to an external wall for reducing heat gain or controlling visible light within a building by shading or deflecting sunlight.

## Appendix B: Performance of materials, products and structures

**Page 135** **Replace** paragraph B4 with the following.

**B4** Where it is proposed to assess the classification of a product or system in lieu of carrying out a specific test (as in paragraph B1c), this should be done in accordance with the relevant standard for extended application for the test in question and should include details of the test evidence that has been used to support the assessment.

For performance classifications where there is no specific standard for extended application, assessment reports should be produced in accordance with the principles of **BS EN 15725** and should include details of the test evidence that has been used to support the assessment. Further information on best practice is provided in the Passive Fire Protection Forum's *Guide to Undertaking Technical Assessments of the Fire Performance of Construction Products Based on Fire Test Evidence*.

**NOTE:** Regulation 7(2) limits components used in or on the **external walls** of certain **buildings** to materials achieving class A2-s1, d0 or class A1 (see Section 12). Assessments cannot be used to demonstrate compliance with this requirement.

**Pages 140 to 143** **Replace** paragraph B25 with the following.

**B25** This document uses the European classification system for **fire resistance** set out in **BS EN 13501-2** to **4**; however, there may be some products lawfully on the market using the classification system set out in previous editions. In those situations the alternative classifications given in Table B3 can be used.

In Table B3 **Specific provisions of the test for fire resistance of elements of structure, etc., replace** rows as follows.

1. **Replace** row 2 with the following.

2. <b>Loadbearing wall</b> (for a wall which is also described in any of the following items, the more onerous guidance should be applied).	R see Table B4	See Table B4	Not applicable	Not applicable	Each side separately
---	----------------	--------------	----------------	----------------	----------------------

2. **Replace** row 3b with the following.

b. in upper storey of two storey dwellinghouse (but not over garage or basement)	R 30 and EI 15	30 min	15 min	15 min	From underside <sup>(5)</sup>
--	----------------	--------	--------	--------	-------------------------------

3. **Replace** row 5b with the following.

b. any part a minimum of 1000mm from the relevant boundary <sup>(6)</sup>	RE see Table B4 and I 15	See Table B4	See Table B4	15 min	From inside the building
---	--------------------------	--------------	--------------	--------	--------------------------



# List of approved documents

The following publications give practical guidance on how to meet the Building Regulations. You can find the date of the edition approved by the Secretary of State at [www.gov.uk](http://www.gov.uk).

## Approved Document A

Structure

## Approved Document B

Fire safety

Volume 1: Dwellings

Volume 2: Buildings other than dwellings

## Approved Document C

Site preparation and resistance to contaminants and moisture

## Approved Document D

Toxic substances

## Approved Document E

Resistance to the passage of sound

## Approved Document F

Ventilation

Volume 1: Dwellings

Volume 2: Buildings other than dwellings

## Approved Document G

Sanitation, hot water safety and water efficiency

## Approved Document H

Drainage and waste disposal

## Approved Document J

Combustion appliances and fuel storage systems

## Approved Document K

Protection from falling, collision and impact

## Approved Document L

Conservation of fuel and power

Volume 1: Dwellings

Volume 2: Buildings other than dwellings

## Approved Document M

Access to and use of buildings

Volume 1: Dwellings

Volume 2: Buildings other than dwellings

## Approved Document O

Overheating

## Approved Document P

Electrical safety – Dwellings

## Approved Document Q

Security – Dwellings

## Approved Document R

Physical infrastructure for high-speed electronic communications networks

## Approved Document S

Infrastructure for the charging of electric vehicles

## Approved Document 7

Materials and workmanship

The Building Regulations 2010, Approved Documents are available from:

### RIBA Books

Online: [www.architecture.com/ribabooks](http://www.architecture.com/ribabooks)

Telephone: +44 (0)20 7496 8383

Email: [sales@books.architecture.com](mailto:sales@books.architecture.com)

### © Crown copyright, 2022

The content of this publication, excluding logos, may be reproduced free of charge in any format or medium for research, private study or for internal circulation within an organisation. This is subject to it being reproduced accurately and not used in a misleading context. The material must be acknowledged as Crown copyright and the title and edition of the publication specified. This document/publication is value added. You may re-use the content (not including logos) free of charge in any format or medium, under the terms of the Open Government Licence.

To view this licence, visit: [www.nationalarchives.gov.uk/doc/open-government-licence](http://www.nationalarchives.gov.uk/doc/open-government-licence) or write to the Information Policy Team, The National Archives, Kew, London TW9 4DU, or email: [psi@nationalarchives.gov.uk](mailto:psi@nationalarchives.gov.uk).

If you require this publication in an alternative format, please email: [alternativeformats@communities.gov.uk](mailto:alternativeformats@communities.gov.uk).

Copyright in the typographical arrangement, excluding logos, of the cover and internal page layouts of this publication rests with the publisher.